

DAIKIN

PCVMT1743aprv



VRV
A SERIES

Cooling Only 50 Hz

R-410A

Exceeding Boundari Innovative Energy Sa



New

VRV A SERIES



Promotion
movie

First launched in Japan in 1982, the Daikin **VRV** system has been embraced by world markets for over 35 years. Now, Daikin proudly introduces the new **VRV A** series. By combining the technologies of **VRV**, **VRT** and **VAV**, we have attained both energy savings and comfortable air conditioning.

VRV+VRT+VAV

Energy savings

Uniting **VRV**, **VRT** and **VAV** technologies

Automatic refrigerant charge function

- Optimised operation efficiency
- Higher installation quality
- Easier installation

es with vings

C o n t e n t s

Main Feature	3
Saves Space and Delivers Excellent Performance	3
Excellent Operational Performance	7
Flexible System Design	9
Reliable and Stable System	11
Outdoor Unit Lineup	13
Outdoor Unit Combinations	14
Outdoor Unit Specifications	15
Indoor Unit Lineup	17
VRV Indoor Units	21
Residential Indoor Units	50
VRV AHU System	55
Air Treatment Equipment Lineup	56
Control Systems	71
Option List	85

High reliability

- New inverter PC board
- Double backup operation
- Refrigerant cooling for PC board

* **VRV** is a trademark of Daikin Industries, Ltd.

Saves Space and Delivers Excellent Performance



New
RXQ-A

Cooling Only
6 HP - 60 HP
(16.0 kW) (168 kW)

Greater energy savings during low-load operation

The key to innovative energy savings is to increase efficiency during low-load operation.

Using data gathered from actual operation, Daikin discovered that air conditioning systems operate at a load factor of 50% or less for 80% of their annual operation period.

This inspired us to develop new technologies to enhance energy efficiency during low loads.

Utilising these technologies, Daikin's new **VRV A series** raises the standard for energy efficiency.

•Correlation between the load factor for the rated capacity and operation time (in office buildings in Singapore)
*According to a survey by Daikin (based on Air Conditioning Network Service System data)

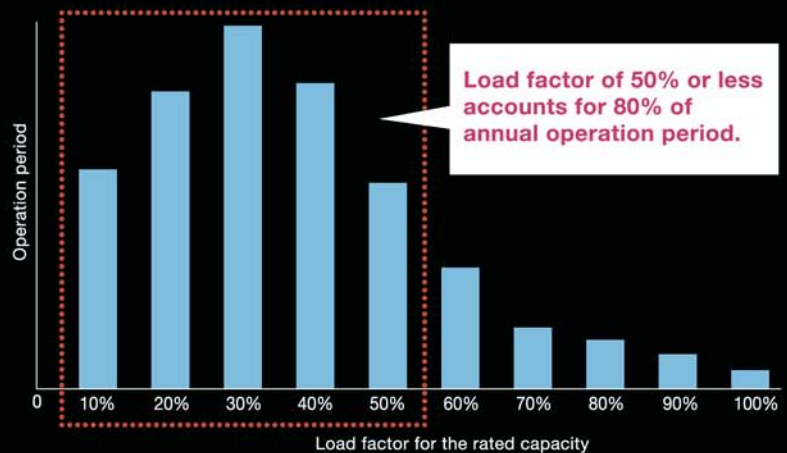

Higher Coefficient of Performance (COP)

COP for 10 HP

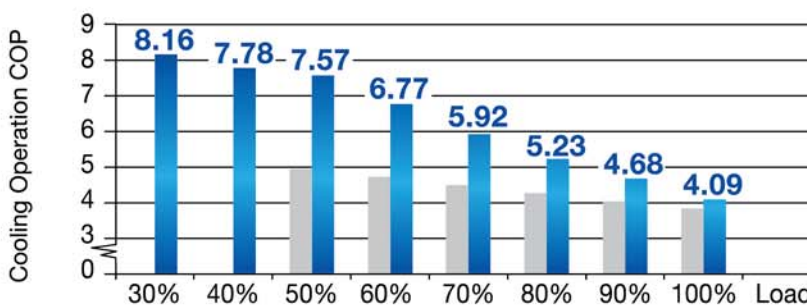

Annual power consumption
14%* lower

* Simulation conditions :
• Location : Bangkok, Thailand
• System : Outdoor unit (10 HP) x 1
Indoor unit (2 HP, Round Flow with Sensing type) x 5
• Operation time : 8:00-20:00 5 days/week
• Outdoor units :
New model : RXQ10AYM (VRV A series)
Conventional model : RXQ10TY1 (VRV IV)

VRV IV (RXQ10T)
VRV A SERIES

*Cooling operation conditions: Indoor temp. of 27°CDB, 19°CWB, and outdoor temp. of 35°CDB.

Advanced technologies for greater energy savings

VRV+VRT+VAV

By uniting advanced **software** and **hardware** technologies for greater energy savings during actual operation and combining the technologies of VRV, VRT and VAV, we have attained both energy savings and comfortable air conditioning.

VRT Smart Control (Fully Automatic Energy-saving Refrigerant Control) Software technology

Optimally supply only for the needed capacity of indoor units

Daikin developed VRT smart control by combining air volume control (VAV: Variable Air Volume) for indoor units with conventional VRT control, which optimises compressor speed by calculating the required load for the entire system and optimal target refrigerant temperature based on data sent from each indoor unit. Coordination with the air volume control reduces compressor load and minimises operation loss based on detailed control. VRT smart control ensures energy savings and comfortable air conditioning to meet actual operating conditions.



•Overview of the control (system control flow)

Different automatic energy-saving refrigerant control applies depending on the indoor units connected.

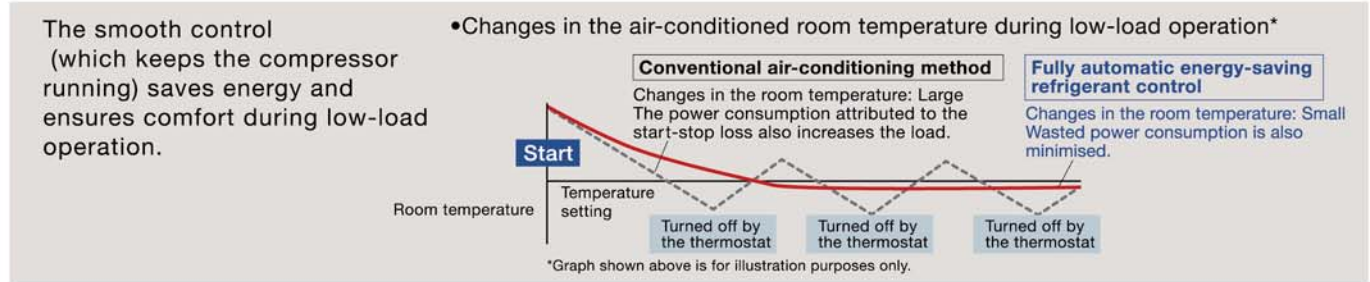
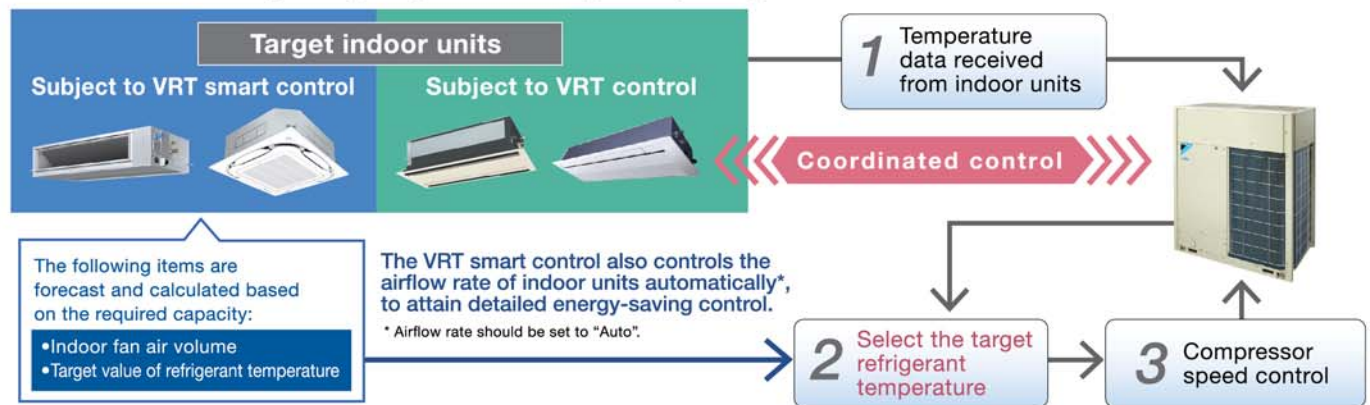

Note:

- For the classification of indoor units (VRT smart control and VRT control), refer to page 17-18.
- If a system has indoor units subject to both VRT smart and VRT control, the system is operated under VRT control.
- If a system has both outdoor-air processing air conditioners and outdoor-air processing type indoor units, VRT smart control and VRT control are disabled.

Optimum utilisation of VRT Smart Control and VRT Control

Effectiveness can be demonstrated for VRT Smart Control and VRT Control when all the indoor units operate under low load conditions in a similar manner.

Low load conditions are the time when room temperature approaches set temperature.

For this reason, please note the following to maximise efficacy.

•When selecting indoor units

Indoor units are installed in a system so that they operate largely under the same conditions.

Energy efficiency decreases for the installation patterns shown below.

Example:

- 1) A load imbalance occurs because an indoor unit in the same system is installed near the perimeter of the room or in the vicinity of a room entrance.
- 2) Different operating hours for indoor units.

•Time of Use

1. Energy efficiency decreases when the set temperature of a specified indoor unit is either excessively lowered during cooling operation.
2. The airflow rate setting is set to "Auto" during VRT Smart Control.

Achieves Space Saving & Excellent Performance

New Scroll Compressor*

Hardware technology

Refrigerant leakage is minimised during low-load operation.

Operation loss due to refrigerant leakage is reduced by the proprietary back pressure control mechanism to ensure stable low-load operation.

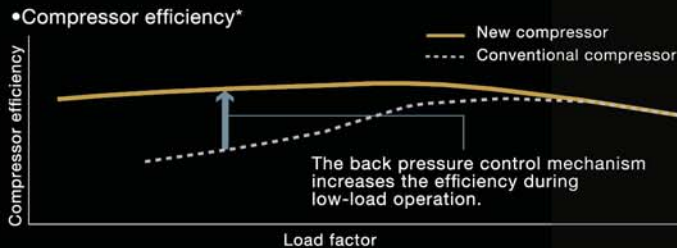

*Graph shown above is for illustration purposes only.

Back pressure control mechanism

Conventional mechanism

The movable scroll is pressed by the pressure difference between high and low pressures. The force pressing the movable scroll decreases during low-load operation, resulting in compression leakage from movable parts.

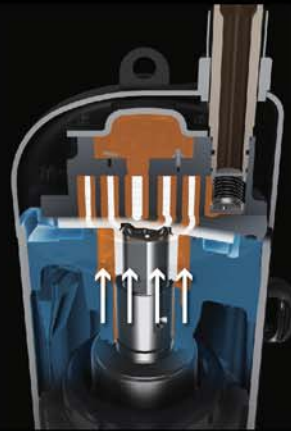

The force pressing the movable scroll decreases during low-load operation.

New intermediate pressure mechanism

The force pressing the movable scroll is optimised according to operating conditions. The behavior of the movable scroll has been stabilised to increase efficiency during low-load operation.

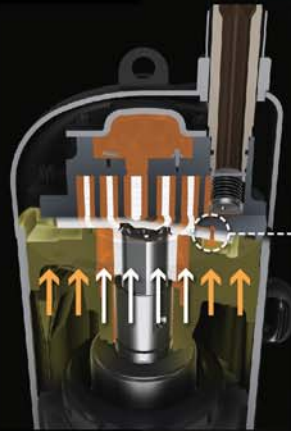

The intermediate pressure keeps pressing the movable scroll during low-load operation.

* The new mechanism is used in RXQ10,12,14 and 20A models.

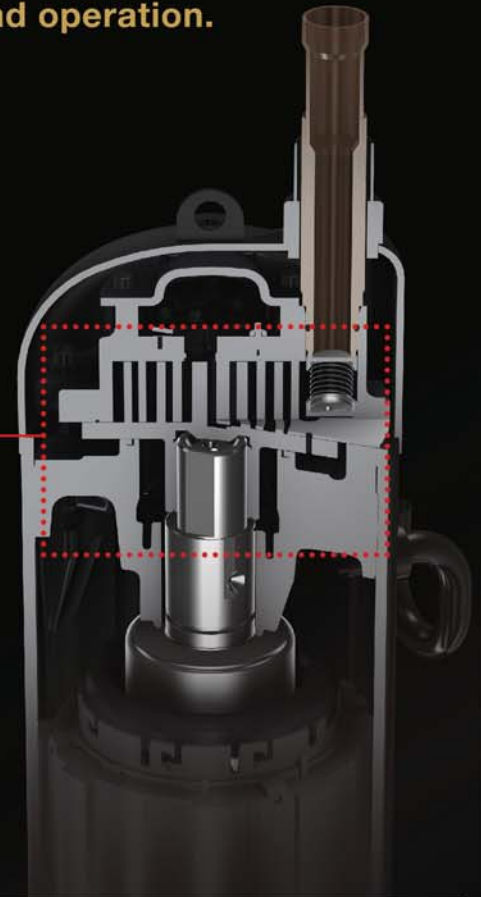

Intermediate pressure adjustment port

The intermediate pressure (back pressure) optimises the force pressing the movable scroll depending on the operating condition.

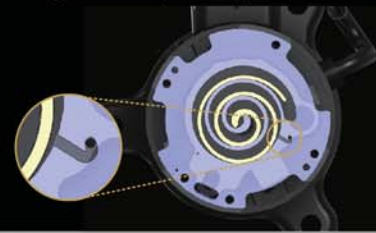

Advanced oil temperature control

Standby power consumption is reduced

The advanced oil temperature control reduces standby power consumption by up to 82.7%* annually compared to conventional models. Standby power needed for preheating refrigerator oil, which consumed substantial standby power, was reduced to save energy when the air conditioner is stopped.

* Operation calculation conditions: VRF A series 14 HP Location: Singapore Operation time: 08:00-18:00 on weekdays.

Automatic refrigerant charge function

Contribute to optimised operation efficiency, higher quality and easier installation

Optimised operation efficiency

The automatic refrigerant charge function automatically determines the optimal amount of refrigerant to be charged. This function prevents a capacity shortage or energy loss due to excessive or insufficient refrigerant.

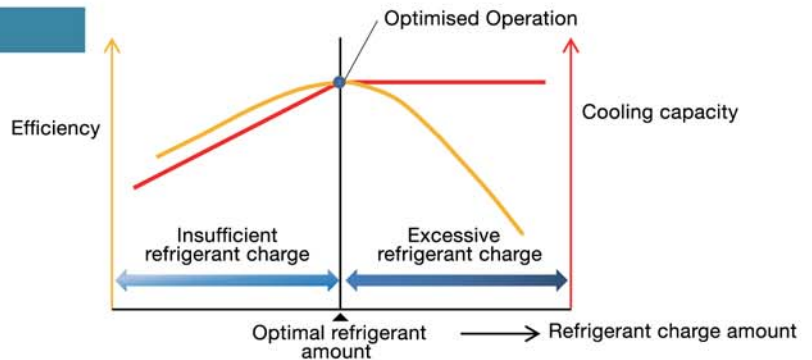

Higher quality and easier installation

The automatic refrigerant charge function automates the charging of the proper refrigerant amount and the closing of shut-off valves by simply pressing a switch after pre-charging. Simplified installation eliminates excessive and insufficient refrigerant charge amounts due to calculation mistakes, and this has led to higher installation quality.

VRV IV

- 1 Calculate necessary refrigerant amount from design drawing
- 2 Recalculate refrigerant amount from final installation drawing
- 3 Charge refrigerant
- 4 Regularly check refrigerant weight on weighing scale
- 5 Complete by manually closing valves when proper weight is reached

VRV A SERIES

- 1 Calculation of necessary refrigerant amount from design drawing
 - 2 Pre-charge of refrigerant*
 - 3 Start of automatic refrigerant charge operation
-

Automatic completion by proper refrigerant amount

Monitoring refrigerant charging is unnecessary

No recalculation of charge amounts due to minor design changes locally

*Pre-charge amount changes according to conditions, and pre-charging is unnecessary when necessary refrigerant amount is 4 kg and under. Please refer to Engineering Data Book for details.

Even if a refrigerant leak occurs from local piping after installation, the proper refrigerant amount can still be charged without needing to calculate the necessary amount.

Starting the automatic refrigerant charge operation again will ensure that optimum operation efficiency and installation quality are maintained.

High reliability

New inverter PC board

The control functions of inverter technology have been integrated on printed circuit boards. As well as improving reliability, this has reduced the number of parts and enabled downsizing.

- New waveform control improves tolerance of variations in power supply voltage. Even if the power supply has irregularities, rises in current are suppressed and operation continues.
- Durability of the inverter printed circuit board improved by changing the electrolytic capacitors for the compressor to film capacitors.

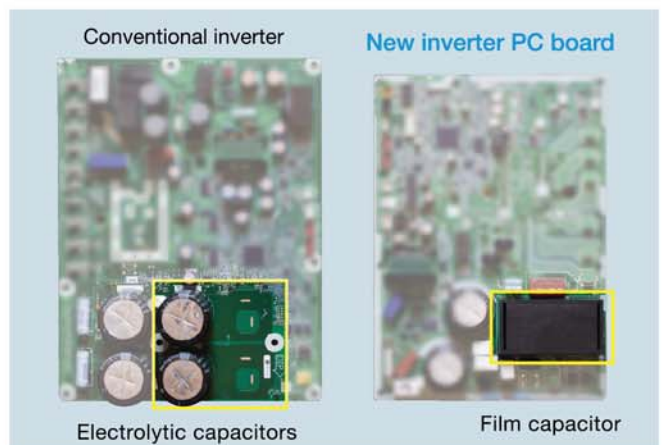

Excellent Operational Performance

Comfort

Low operation sound

High efficiency heat exchanger helps to achieve low operation sound.

	Sound level(dB(A))			
	6/8 HP	10 HP	12 HP	14/16 HP
VRV A SERIES	56	57	59	60

Large airflow, high static pressure and quiet technology

Advanced analytic technologies are utilised to optimise fan design and increase airflow rate and high external static pressure.

Streamlined air grille

It promotes the discharge of swirling airflow, further reducing pressure loss.





Streamlined scroll fan

The curvature of each fan blade edge reduces both vibration and pressure loss.

Streamlined scroll fan





Illustrated fan





Nighttime quiet operation function

For areas with stringent restrictions placed on outdoor sound levels, the outdoor unit can be set for low operation sound during the nighttime to meet sound restrictions.

The automatic night quiet mode will initiate 8 hours*1 after the peak temperature is reached in the daytime, and normal operation will resume 9 hours*2 after that.

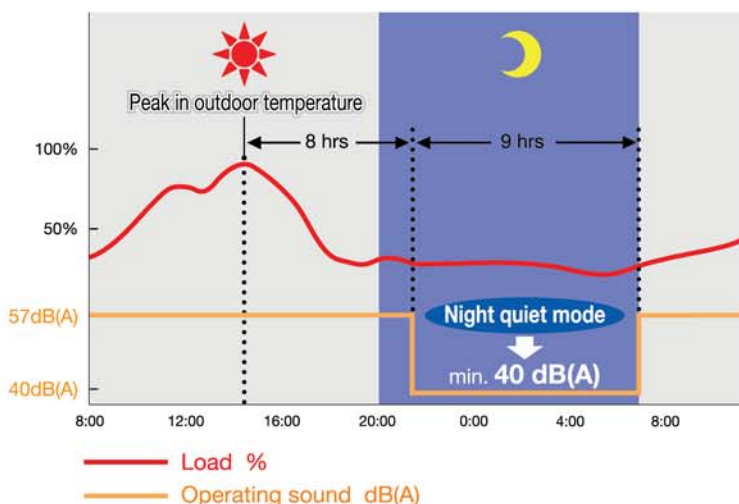
*1. Initial setting is 8 hours. Can be selected from 6, 8 and 10 hours.
 *2. Initial setting is 9 hours. Can be selected from 8, 9 and 10 hours.
 *3. In case of 10 HP outdoor unit.



Note:

- This function is available in setting at site.
- The operating sound in quiet operation mode is the actual value measured by our company.
- The relationship of outdoor temperature (load) and time shown above is just an example.

Compact design with high performance

Highly integrated heat exchanger

The unique 4-sided all round heat exchanger ensures sufficient surface area for the heat exchanger. This improves the heat exchanger performance without increasing the footprint.

Waffle Fin
A waffled-shaped fin with fin pitch of 1.4 mm was adopted to realise sufficient heat exchanger area for optimum unit efficiency.

4-sided heat exchanger

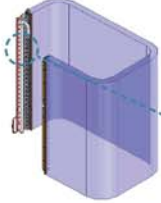

High efficiency heat exchanger is realised by reducing airflow resistance with adoption of small cooling tubes with a diameter of $\square 7$.

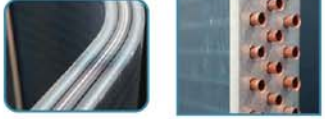

20 HP
3-row small pipe design increases heat transfer efficiency.

VRV A SERIES

Optimised inner design to ensure smooth airflow

Electric components were downsized and positioned in the dead space of the bell mouth side to decrease airflow resistance.

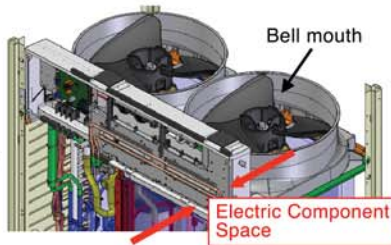

Easy maintenance

The electrical components are strategically located on the top which eases the maintenance process. Moreover, the heat exchanger on the front side can be used effectively to improve its performance.



Sufficient cooling for electrical components

The VRV A series is designed with the electrical box strategically positioned between a region of positive and negative pressure. This design allows large airflow from negative pressure to positive pressure due to the high pressure difference.

• High pressure since air enters near the fan blower inlet

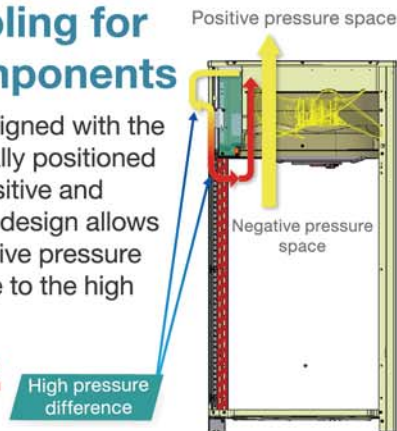

Eliminate suction resistance issue

Without affecting the fan volume, the electric components are designed to be at the top and this utilises dead space. This eliminates the problem of suction resistance.

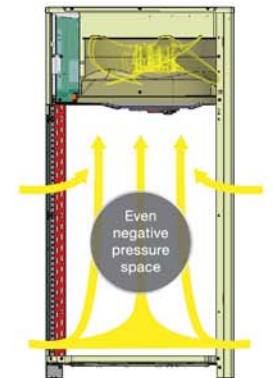

High reliability at high ambient temperatures

It is possible to keep operation stable even at high ambient temperatures by cooling the inverter power module. This helps maintain air-conditioning capacity and reduces failure ratio.



PC Board

Heat

Power Module

Refrigerant

Refrigerant Refrigerant Jacket

Using refrigerant to cool the inverter power module helps minimise the size of the electronic components, and this results in reduction of airflow resistance and high efficiency of the heat exchanger.

Control board failure ratio at stable operation is reduced.

Outer Rotor DC Motor (ODM)

Only Daikin has adapted an ODM with the feature of stable rotation and volumetric efficiency.

Advantages of ODM

- ① Large torque with same electromagnetic force
- ② Stable rotation in all ranges and can be operated with small number of rotations

UNIQUE

ODM (Outer Type)

Conventional Motor (Inner Type)

Rotor

Rotor

HIGH TORQUE with low energy

MORE efficient

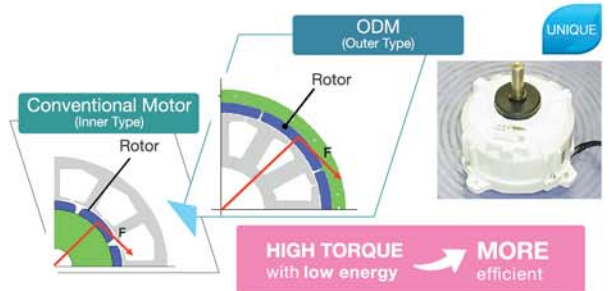

Flexible System Design

More options for installation location

Long piping length

The long piping length provides more design flexibility, which can match even large-sized buildings.

For connection of only VRV indoor units

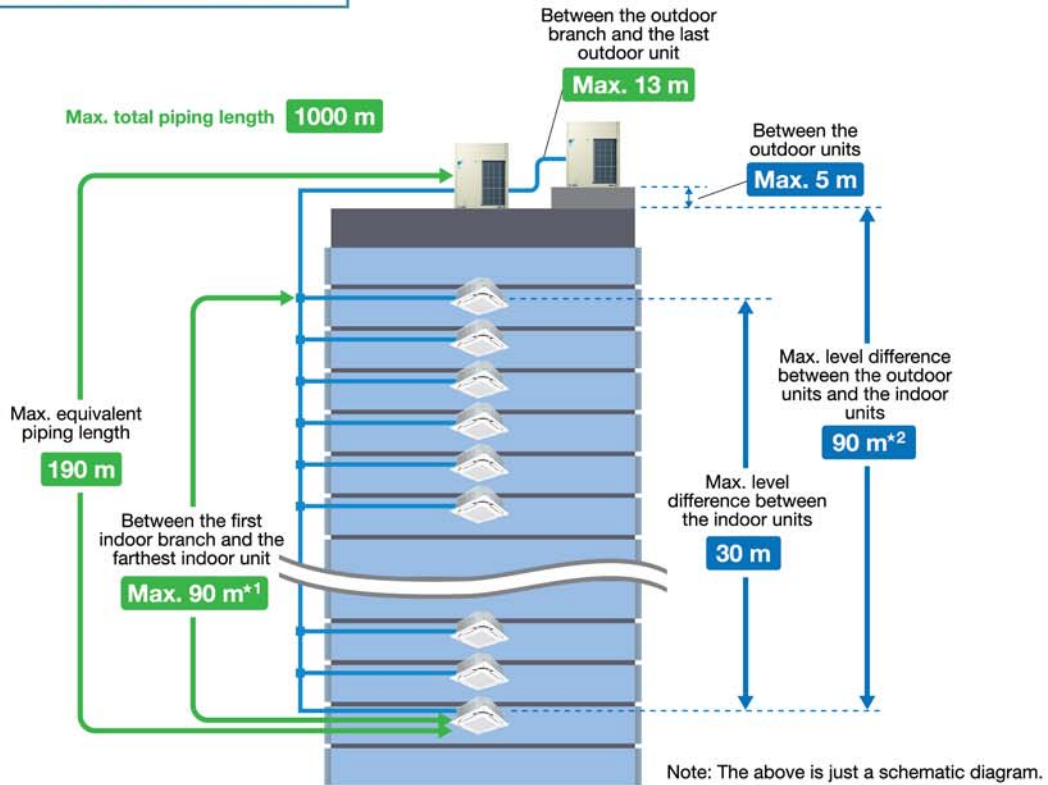

Maximum allowable piping length	Actual piping length (Equivalent)	165 m (190 m)
	Total piping length	1000 m
	Between the first indoor branch and the farthest indoor unit	90 m ^{*1}
	Between the outdoor branch and the last outdoor unit (Equivalent)	10 m (13 m)
Maximum allowable level difference	Between the outdoor units (Multiple use)	5 m
	Between the indoor units	30 m
	Between the outdoor units and the indoor units	90 m ^{*2}

- *1. No special requirements up to 40 m. The maximum actual piping length can be 90 m, depending on conditions. Various conditions and requirements have to be met to allow utilisation of 90 m piping length. Be sure to refer to the Engineering Data Book for details of these conditions and requirements.
- *2. When level differences are 50 m or more, the diameter of the main liquid piping size must be increased. If the outdoor unit is above the indoor unit, a dedicated setting on the outdoor unit is required. Refer to the Engineering Data Book and contact your local dealer for more information.

Connection ratio

Connection capacity at maximum is 200%.

Connection ratio
50%–200%

Connection ratio =

$$\frac{\text{Total capacity index of the indoor units}}{\text{Capacity index of the outdoor units}}$$

Conditions of VRV indoor unit connection capacity

Applicable VRV indoor units	Other VRV indoor unit models ^{*1}
Single outdoor units	200%
Double outdoor units	160%
Triple outdoor units	130%

*1 For the FXF(S)Q25 and FXVQ models, maximum connection ratio is 130% for the entire range of outdoor units.

Note: If the operational capacity of indoor units is more than 130%, low airflow operation is enforced in all the indoor units.

*Refer to page 14 for outdoor unit combination details.

For mixed combination of VRV and residential indoor units

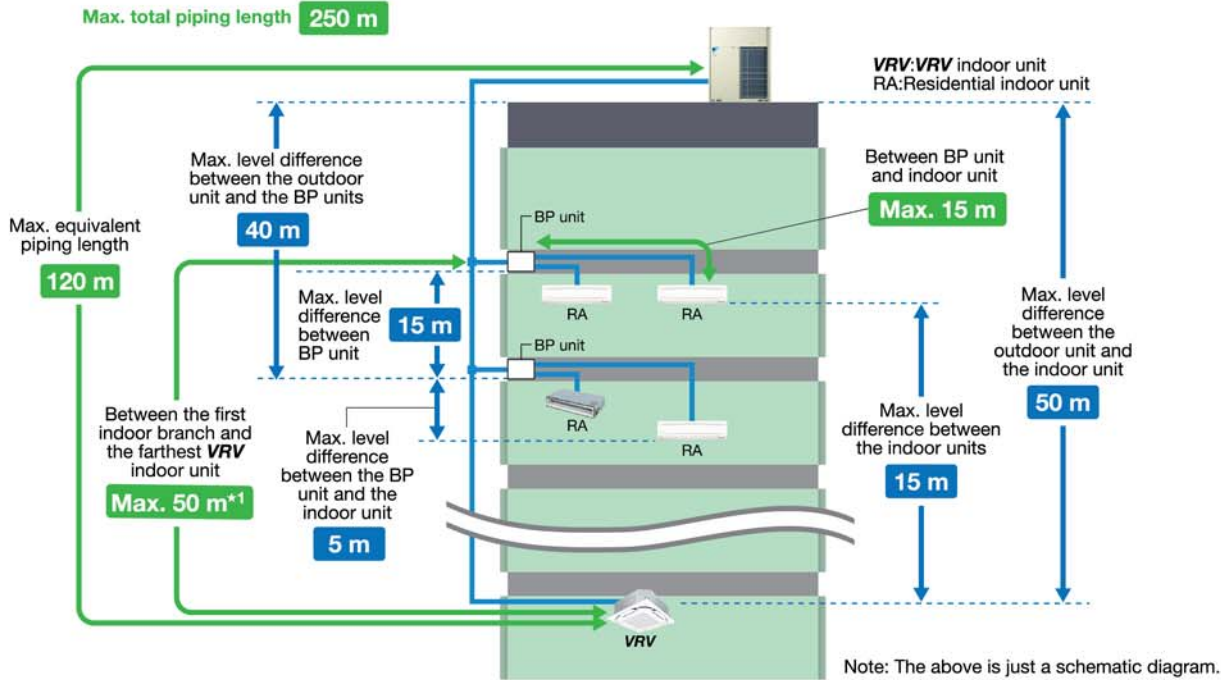

When a mixed combination of VRV and residential indoor units is connected or when only residential indoor units are connected

	Actual piping length (Equivalent)	100 m (120 m)
	Total piping length	250 m
Maximum allowable piping length	Between BP unit and indoor unit	If indoor unit capacity index < 60. 2 m–15 m If indoor unit capacity index is 60. 2 m–12 m If indoor unit capacity index is 71. 2 m–8 m
	Between the first indoor branch and the farthest BP unit or between the first indoor branch and the farthest VRV indoor unit	50 m*1
	Between outdoor unit and the first indoor branch	5 m
	Between the indoor units	15 m
Maximum allowable level difference	Between BP units	15 m
	Between the outdoor unit and the indoor unit	If the outdoor unit is above. 50 m If the outdoor unit is below. 40 m
	Between the outdoor unit and the BP unit	40 m
	Between the BP unit and the indoor unit	5 m

*1. If the piping length between the first indoor branch and BP unit or VRV indoor unit is over 20 m, it is necessary to increase the gas and liquid piping size between the first indoor branch and BP unit or VRV indoor unit. If the piping diameter of the sized up piping exceeds the diameter of the piping before the first indoor branch kit, then the latter also requires a liquid piping and gas piping size up. Please refer to Engineering Data Book for details.

*When a mixed combination of VRV and residential indoor units is connected or when only residential indoor units are connected, connection ratio must be 50% to 130%. Refer to page 14 for outdoor unit combination details.

High external static pressure

VRV A series outdoor unit has been achieved high external static pressure up to 78.4 Pa, ensuring the efficient heat dissipation and stable operation of equipment in either hierarchical or intensive arrangement.

78.4 Pa

- More options in the opening/angle of louvre
- Outstanding heat dissipation effect in both hierarchical and intensive arrangement



Reliable and Stable System

More accurate test operation and stable system

Efficient automatic test operation

Daikin **VRV** A series incorporates a simplified and efficient test operation function, that not only greatly accelerates the installation process, but also effectively improves the field setting quality.

- Automatically checks the wiring between outdoor units and indoor units to confirm whether there is defective wiring.
- Confirms piping length to optimise operation.
- Automatically checks whether the stop valve in each outdoor unit is functioning normally to ensure the smooth operation of air conditioning system.

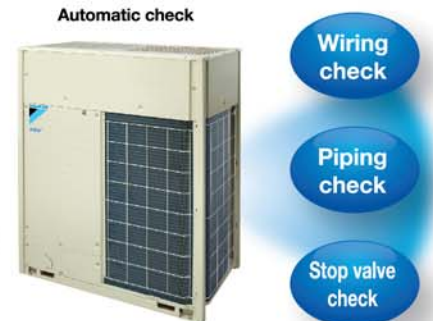

Simplified commissioning and after-sales service

Function of information display by luminous digital tube

VRV A series utilises 7-segment luminous digital tubes to display system operation information, enabling the operational state to be visually displayed whilst facilitating simplified commissioning and after-sales service.

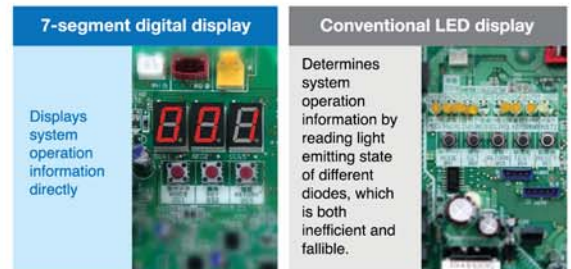

Advanced control main PC board

SMT* packaging technology

- SMT packaging technology adopted by the computer control panel improves the anti-clutter performance.
- Protects your computer boards from the adverse effects of sandy climates and humid weather.

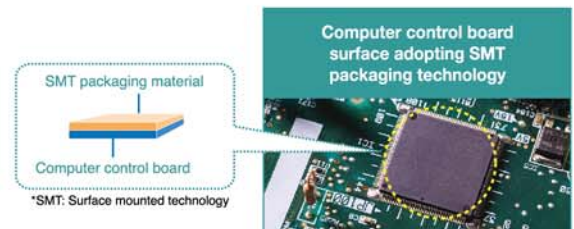

I-demand function

Limit to power consumption can be set precisely to one of 11 levels. Peak power cut-off can be accomplished according to each user situation.

*Set on the circuit board of the outdoor unit.

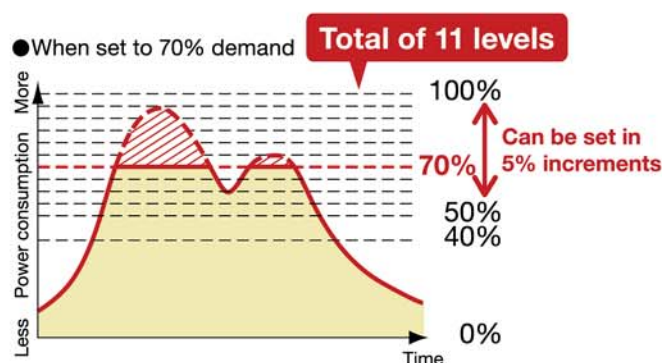

Wide operation temperature range up to 49°C

The versatile operation range of the **VRV** A series works to reduce limitations on installation locations.

The operation temperature range for cooling can be performed with outdoor temperatures as high as 49°C.

This enables reliable operation even under high temperature conditions.

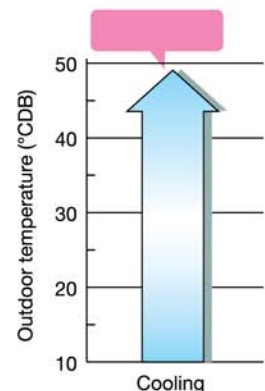

Note: When outdoor temperature falls below 10°C, the thermostat shuts OFF, the outdoor unit stops, and operation switches from cooling to fan operation.

Automatic sequencing operation

During start-up, Daikin **VRV** A series outdoor unit sequencing operation will be automatically enabled to ensure balance operation of each outdoor unit to improve longevity of equipment and stable operation.

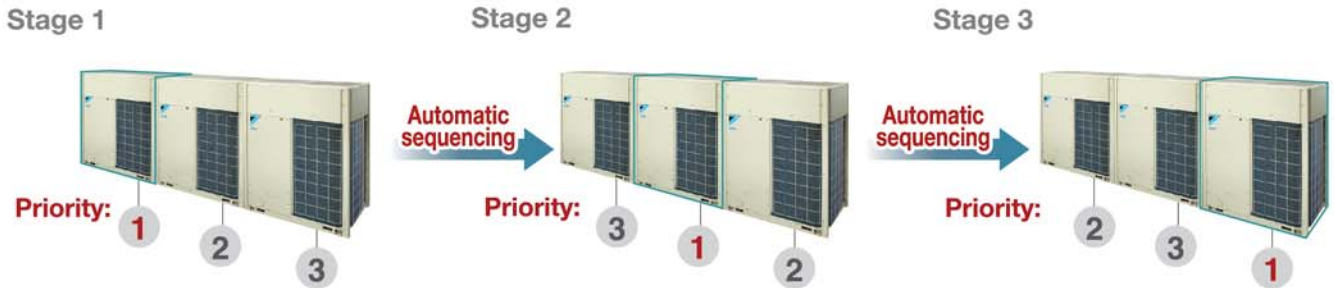

VRV A SERIES

Double backup operation functions

Daikin **VRV** A series outdoor unit boasts double backup operation functions, which can secure the use of air conditioners in this area to the greatest extent in an emergency by enabling double backup operation functions even if failure occurs in a set of air conditioning equipment.

In the event of a failure, emergency operation can be conveniently enabled to allow the remaining system to operate in a limited fashion.

Unit backup operation function

If one of the units in a multiple outdoor system malfunctions, the other outdoor units provide emergency operation until repairs can be made.

* For systems composed of two or more outdoor units.



Compressor backup operation function

The outdoor unit is equipped with two compressors. Even if one compressor malfunctions, the other compressor provides emergency operation, reducing the risk of air conditioning shutdown due to compressor failure. (Capacity is saved during backup operation.)

* For single outdoor unit system RXQ16-20AYM models. On-site settings are required using the printed circuit board of the outdoor unit.



Ease of Maintenance

VRV A series provides a maintenance feature* which allows the shutdown of indoor unit without shutting down the whole **VRV** system. This feature comes in handy during maintenance period as the remaining indoor units continue to operate.

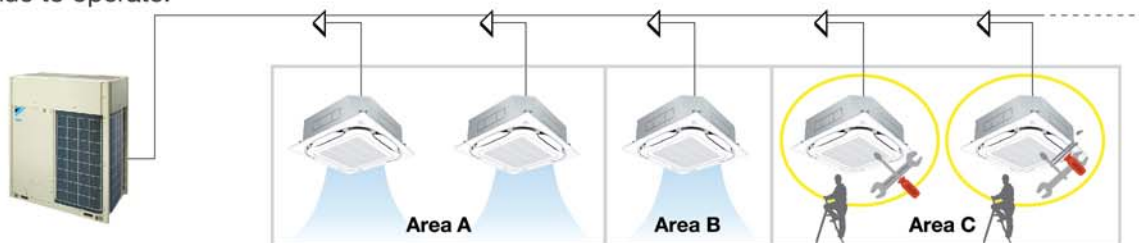

* Field setting is required.
This feature does not apply to residential indoor unit connection.
For more information, please contact Daikin sales office.

Outdoor Unit Lineup

VRV A Series Outdoor Units New

The outdoor unit capacity is up to 60 HP (168 kW) in increment of 2 HP.

- VRV A series outdoor unit offers a high capacity of up to 60 HP, responding to the needs of large-sized building.
- The single outdoor unit has only 2 shape and dimensions, not only simplifying the design process, but also bringing the system flexibility to a new level.
- With the outdoor unit capacity increased in increment of 2 HP, customers' needs can be precisely met.

Lineup

HP		6	8	10	12	14	16	18	20	22	24	26	28	30	32	34	36	38	40	42	44	46	48	50	52	54	56	58	60
VRV A SERIES	Single module	●	●	●	●	●	●	●	●	—	—	—	—	—	—	—	—	—	—	—	—	—	—	—	—	—	—	—	—
	Multi type	—	—	—	—	—	—	●	●	●	●	●	●	●	●	●	●	●	●	●	●	●	●	●	●	●	●	●	●

•Single Outdoor Units

6, 8, 10, 12 HP 14, 16, 18, 20 HP



RXQ6AY1S
RXQ8AY1S
RXQ10AY1S
RXQ12AY1S



RXQ14AY1S
RXQ16AY1S
RXQ18AY1S
RXQ20AY1S

•Double Outdoor Units

18, 20, 22, 24 HP 26, 28, 30 HP



RXQ18AMYS
RXQ20AMYS
RXQ22AMYS
RXQ24AMYS



RXQ26AMYS
RXQ28AMYS
RXQ30AMYS

32, 34, 36, 38, 40 HP



RXQ32AMYS
RXQ34AMYS
RXQ36AMYS
RXQ38AMYS
RXQ40AMYS

•Triple Outdoor Units

42, 44 HP



RXQ42AMYS
RXQ44AMYS

46, 48, 50, 52, 54, 56, 58, 60 HP



RXQ46AMYS
RXQ48AMYS
RXQ50AMYS
RXQ52AMYS

RXQ54AMYS
RXQ56AMYS
RXQ58AMYS
RXQ60AMYS

VRV X SERIES

Cooling Only 6 HP–60 HP



New

RXUQ-A

Lineup

HP		6	8	10	12	14	16	18	20	22	24	26	28	30	32	34	36	38	40	42	44	46	48	50	52	54	56	58	60
VRV X SERIES	Single module	●	●	●	●	●	●	●	●	●	—	—	—	—	—	—	—	—	—	—	—	—	—	—	—	—	—	—	—
	Multi type	—	—	—	●	●	●	●	●	●	●	●	●	●	●	●	●	●	●	●	●	●	●	●	●	●	●	●	●

● New lineup

Preliminary Information

New Heights in Energy Efficiency During Actual Operation

- The VRV X series features new models specially developed for high efficiency.
- All compressors used in outdoor units are new scroll compressors designed to enhance energy efficiency.

Outdoor Unit Combinations

For connection of VRV indoor units

HP	kW	Capacity index	Model name	Combination	Outdoor unit multi connection piping kit ^{*1}	Total capacity index of connectable indoor units ^{*2}	Maximum number of connectable indoor units ^{*2}
6 HP	16.0	150	RXQ6A	RXQ6A	–	75 to 195 (300)	9 (15)
8 HP	22.4	200	RXQ8A	RXQ8A	–	100 to 260 (400)	13 (20)
10 HP	28.0	250	RXQ10A	RXQ10A	–	125 to 325 (500)	16 (25)
12 HP	33.5	300	RXQ12A	RXQ12A	–	150 to 390 (600)	19 (30)
14 HP	40.0	350	RXQ14A	RXQ14A	–	175 to 455 (700)	22 (35)
16 HP	45.0	400	RXQ16A	RXQ16A	–	200 to 520 (800)	26 (40)
18 HP	50.0	450	RXQ18A	RXQ18A	–	225 to 585 (900)	29 (45)
20 HP	56.0	500	RXQ20A	RXQ20A	–	250 to 650 (1,000)	32 (50)
18 HP	50.4	450	RXQ18AM	RXQ8A + RXQ10A	BHFP22P100	225 to 585 (720)	29 (36)
20 HP	55.9	500	RXQ20AM	RXQ8A + RXQ12A		250 to 650 (800)	32 (40)
22 HP	61.5	550	RXQ22AM	RXQ10A + RXQ12A		275 to 715 (880)	35 (44)
24 HP	67.0	600	RXQ24AM	RXQ12A × 2		300 to 780 (960)	39 (48)
26 HP	73.5	650	RXQ26AM	RXQ12A + RXQ14A		325 to 845 (1,040)	42 (52)
28 HP	78.5	700	RXQ28AM	RXQ12A + RXQ16A		350 to 910 (1,120)	45 (56)
30 HP	83.5	750	RXQ30AM	RXQ12A + RXQ18A		375 to 975 (1,200)	48 (60)
32 HP	90.0	800	RXQ32AM	RXQ14A + RXQ18A		400 to 1,040 (1,280)	52 (64)
34 HP	95.0	850	RXQ34AM	RXQ16A + RXQ18A		425 to 1,105 (1,360)	55 (64)
36 HP	100	900	RXQ36AM	RXQ18A × 2		450 to 1,170 (1,440)	58 (64)
38 HP	106	950	RXQ38AM	RXQ18A + RXQ20A		475 to 1,235 (1,520)	61 (64)
40 HP	112	1,000	RXQ40AM	RXQ20A × 2		500 to 1,300 (1,600)	64 (64)
42 HP	117	1,050	RXQ42AM	RXQ12A × 2 + RXQ18A		525 to 1,365 (1,365)	
44 HP	123	1,100	RXQ44AM	RXQ12A × 2 + RXQ20A		550 to 1,430 (1,430)	
46 HP	130	1,150	RXQ46AM	RXQ14A × 2 + RXQ18A		575 to 1,495 (1,495)	
48 HP	135	1,200	RXQ48AM	RXQ14A + RXQ16A + RXQ18A		600 to 1,560 (1,560)	
50 HP	140	1,250	RXQ50AM	RXQ14A + RXQ18A × 2	625 to 1,625 (1,625)		
52 HP	145	1,300	RXQ52AM	RXQ16A + RXQ18A × 2	650 to 1,690 (1,690)		
54 HP	150	1,350	RXQ54AM	RXQ18A × 3	675 to 1,755 (1,755)		
56 HP	156	1,400	RXQ56AM	RXQ18A × 2 + RXQ20A	700 to 1,820 (1,820)		
58 HP	162	1,450	RXQ58AM	RXQ18A + RXQ20A × 2	725 to 1,885 (1,885)		
60 HP	168	1,500	RXQ60AM	RXQ20A × 3	750 to 1,950 (1,950)		

Note: ^{*1}. For multiple connection, the outdoor unit multi connection piping kit (separately sold) is required.

^{*2}. Values inside brackets are based on connection of indoor units rated at maximum capacity, 200% for single outdoor units, 160% for double outdoor units, and 130% for triple outdoor units.

For mixed combination of VRV and residential indoor units or connection of residential indoor units only

Model name ^{*1}	kW	HP	Capacity index	Total capacity index of connectable indoor units ^{*2}			Maximum number of connectable indoor units
				Combination (%) ^{*2}			
				50%	100%	130%	
RXQ6AY1S	16.0	6	150	75	150	195	9
RXQ8AY1S	22.4	8	200	100	200	260	13
RXQ10AY1S	28.0	10	250	125	250	325	16
RXQ12AY1S	33.5	12	300	150	300	390	19
RXQ14AY1S	40.0	14	350	175	350	455	22
RXQ16AY1S	45.0	16	400	200	400	520	26
RXQ18AY1S	50.0	18	450	225	450	585	29
RXQ20AY1S	56.0	20	500	250	500	650	32



Note: ^{*1}. Only single outdoor unit (RXQ6-20AY1S) can be connected.

^{*2}. Total capacity index of connectable indoor units must be 50%–130% of the capacity index of the outdoor unit.

Specifications

VRV A Series Outdoor Units

RXQ-A

									
MODEL			RXQ6AY1S	RXQ8AY1S	RXQ10AY1S	RXQ12AY1S	RXQ14AY1S	RXQ16AY1S	RXQ18AY1S
Combination units			—	—	—	—	—	—	—
			—	—	—	—	—	—	—
Power supply			3 phase 4-wire system, 380-415V/ 380V, 50Hz/ 60Hz						
Cooling capacity	Btu/h		54,600	76,400	95,500	114,000	136,000	154,000	171,000
	kW		16.0	22.4	28.0	33.5	40.0	45.0	50.0
Power consumption	kW		3.38	5.17	6.84	8.70	10.7	12.9	15.3
Capacity Control	%		25-100	20-100	13-100	12-100	11-100	10-100	10-100
Casing colour			Ivory white (5Y7.5/1)						
Compressor	Type		Hermetically sealed scroll type						
	Motor Output× Number of Units	kW	2.3×1	3.4×1	4.5×1	5.6×1	6.4×1	(3.5×1)+(3.5×1)	(4.0×1)+(4.0×1)
Airflow rate	m ³ /min		119	178		191	257		
Dimensions (H×W×D)	mm		1,657×930×765				1,657×1,240×765		
Machine weight	kg		175		185		215	260	
Sound level	dB(A)		56		57	59	60		61
Operation range	°CDB		10 to 49						
Refrigerant	Type		R-410A						
	Charge	kg	5.9		6.7	6.8	7.4	8.2	8.4
Piping connections	Liquid	mm	φ9.5 (Brazing)			φ12.7 (Brazing)			φ15.9 (Brazing)
	Gas	mm	φ19.1 (Brazing)		φ22.2 (Brazing)	φ28.6 (Brazing)			



									
MODEL			RXQ32AMYS	RXQ34AMYS	RXQ36AMYS	RXQ38AMYS	RXQ40AMYS	RXQ42AMYS	RXQ44AMYS
Combination units			RXQ14AY1S	RXQ16AY1S	RXQ18AY1S	RXQ18AY1S	RXQ20AY1S	RXQ12AY1S	RXQ12AY1S
			RXQ18AY1S	RXQ18AY1S	RXQ18AY1S	RXQ20AY1S	RXQ20AY1S	RXQ12AY1S	RXQ12AY1S
			—	—	—	—	—	RXQ18AY1S	RXQ20AY1S
Power supply			3 phase 4-wire system, 380-415V/ 380V, 50Hz/ 60Hz						
Cooling capacity	Btu/h		307,000	324,000	341,000	362,000	382,000	399,000	420,000
	kW		90.0	95.0	100	106	112	117	123
Power consumption	kW		26.0	28.2	30.6	33.0	35.4	32.7	35.1
Capacity Control	%		5-100	5-100	5-100	4-100	3-100	4-100	3-100
Casing colour			Ivory white (5Y7.5/1)						
Compressor	Type		Hermetically sealed scroll type						
	Motor Output× Number of Units	kW	(6.4×1)+(4.0×1) +(4.0×1)	(3.5×1)+(3.5×1) +(4.0×1)+(4.0×1)	(4.0×1)+(4.0×1) +(4.0×1)+(4.0×1)	(4.0×1)+(4.0×1) +(3.8×1)+(6.3×1)	(3.8×1)+(6.3×1) +(3.8×1)+(6.3×1)	(5.6×1)+(5.6×1) +(4.0×1)+(4.0×1)	(5.6×1)+(5.6×1) +(3.8×1)+(6.3×1)
Airflow rate	m ³ /min		257+257			257+297	297+297	191+191+257	191+191+297
Dimensions (H×W×D)	mm		(1,657×1,240×765)+(1,657×1,240×765)					(1,657×930×765)+(1,657×930×765)+ (1,657×1,240×765)	
Machine weight	kg		215+260	260+260		260+285	285+285	185+185+260	185+185+285
Sound level	dB(A)		64			66	68	65	67
Operation range	°CDB		10 to 49						
Refrigerant	Type		R-410A						
	Charge	kg	7.4+8.4	8.2+8.4	8.4+8.4	8.4+11.8	11.8+11.8	6.8+6.8+8.4	6.8+6.8+11.8
Piping connections	Liquid	mm	φ19.1 (Brazing)						
	Gas	mm	φ34.9 (Brazing)			φ41.3 (Brazing)			

Note: Specifications are based on the following conditions;

•Cooling: Indoor temp.: 27°CDB, 19°CWB, Outdoor temp.: 35°CDB, Equivalent piping length: 7.5 m, Level difference: 0 m.

•Sound level: Anechoic chamber conversion value, measured at a point 1 m in front of the unit at a height of 1.5 m.

During actual operation, these values are normally somewhat higher as a result of ambient conditions.

								
RXQ20AY1S	RXQ18AMYS	RXQ20AMYS	RXQ22AMYS	RXQ24AMYS	RXQ26AMYS	RXQ28AMYS	RXQ30AMYS	
—	RXQ8AY1S	RXQ8AY1S	RXQ10AY1S	RXQ12AY1S	RXQ12AY1S	RXQ12AY1S	RXQ12AY1S	
—	RXQ10AY1S	RXQ12AY1S	RXQ12AY1S	RXQ12AY1S	RXQ14AY1S	RXQ16AY1S	RXQ18AY1S	
3 phase 4-wire system, 380-415V/ 380V, 50Hz/ 60Hz								
191,000	172,000	191,000	210,000	229,000	251,000	268,000	285,000	
56.0	50.4	55.9	61.5	67.0	73.5	78.5	83.5	
17.7	12.0	13.9	15.5	17.4	19.4	21.6	24.0	
7-100	7-100	7-100	6-100	6-100	6-100	5-100	5-100	
Ivory white (5Y7.5/1)								
Hermetically sealed scroll type								
(3.8×1)+(6.3×1)	(3.4×1)+(4.5×1)	(3.4×1)+(5.6×1)	(4.5×1)+(5.6×1)	(5.6×1)+(5.6×1)	(5.6×1)+(6.4×1)	(5.6×1)+(3.5×1) +(3.5×1)	(5.6×1)+(4.0×1) +(4.0×1)	
297	178+178	178+191		191+191	191+257			
1,657×1,240×765	(1,657×930×765)+(1,657×930×765)				(1,657×930×765)+(1,657×1,240×765)			
285	175+185		185+185		185+215	185+260		
65	60	61		62	63			
10 to 49								
R-410A								
11.8	5.9+6.7	5.9+6.8	6.7+6.8	6.8+6.8	6.8+7.4	6.8+8.2	6.8+8.4	
φ15.9 (Brazing)					φ19.1 (Brazing)			
φ28.6 (Brazing)				φ34.9 (Brazing)				

							
RXQ46AMYS	RXQ48AMYS	RXQ50AMYS	RXQ52AMYS	RXQ54AMYS	RXQ56AMYS	RXQ58AMYS	RXQ60AMYS
RXQ14AY1S	RXQ14AY1S	RXQ14AY1S	RXQ16AY1S	RXQ18AY1S	RXQ18AY1S	RXQ18AY1S	RXQ20AY1S
RXQ14AY1S	RXQ16AY1S	RXQ18AY1S	RXQ18AY1S	RXQ18AY1S	RXQ18AY1S	RXQ20AY1S	RXQ20AY1S
RXQ18AY1S	RXQ18AY1S	RXQ18AY1S	RXQ18AY1S	RXQ18AY1S	RXQ20AY1S	RXQ20AY1S	RXQ20AY1S
3 phase 4-wire system, 380-415V/ 380V, 50Hz/ 60Hz							
444,000	461,000	478,000	495,000	512,000	532,000	553,000	573,000
130	135	140	145	150	156	162	168
36.7	38.9	41.3	43.5	45.9	48.3	50.7	53.1
3-100	3-100	3-100	3-100	3-100	3-100	2-100	2-100
Ivory white (5Y7.5/1)							
Hermetically sealed scroll type							
(6.4×1)+(6.4×1) +(4.0×1)+(4.0×1)	(6.4×1)+(3.5×1)+(3.5×1) +(4.0×1)+(4.0×1)	(6.4×1)+(4.0×1)+(4.0×1) +(4.0×1)+(4.0×1)	(3.5×1)+(3.5×1)+(4.0×1) +(4.0×1)+(4.0×1)+(4.0×1)	(4.0×1)+(4.0×1)+(4.0×1) +(4.0×1)+(4.0×1)+(4.0×1)	(4.0×1)+(4.0×1)+(4.0×1) +(4.0×1)+(3.8×1)+(6.3×1)	(4.0×1)+(4.0×1)+(3.8×1) +(6.3×1)+(3.8×1)+(6.3×1)	(3.8×1)+(6.3×1)+(3.8×1) +(6.3×1)+(3.8×1)+(6.3×1)
257+257+257					257+257+297	257+297+297	297+297+297
(1,657×1,240×765)+(1,657×1,240×765)+(1,657×1,240×765)							
215+215+260	215+260+260		260+260+260		260+260+285	260+285+285	285+285+285
65			66		68	69	70
10 to 49							
R-410A							
7.4+7.4+8.4	7.4+8.2+8.4	7.4+8.4+8.4	8.2+8.4+8.4	8.4+8.4+8.4	8.4+8.4+11.8	8.4+11.8+11.8	11.8+11.8+11.8
φ19.1 (Brazing)							
φ41.3 (Brazing)							

Indoor Unit Lineup

Enhanced range of choices

A mixed combination of **VRV** indoor units and residential indoor units is enabled all in one system, opening the door to stylish and quiet indoor units.

VRV indoor units

New lineup

VRT smart

Indoor units subject to VRT smart control

VRT

Indoor units subject to VRT control

Type	Model Name	Capacity Range	20	25	32	40	50	63	71	80	100	125	140	200	250	400	500	
			Capacity Index	0.8 HP	1 HP	1.25 HP	1.6 HP	2 HP	2.5 HP	3 HP	3.2 HP	4 HP	5 HP	6 HP	8 HP	10 HP	16 HP	20 HP
			Capacity Index	20	25	31.25	40	50	62.5	71	80	100	125	140	200	250	400	500
Ceiling Mounted Cassette (Round Flow with Sensing)	FXFSQ-AVS																	
Ceiling Mounted Cassette (Round Flow)	FXFQ-AVS																	
Ceiling Mounted Cassette (Compact Multi Flow)	FXZQ-MVES																	
Ceiling Mounted Cassette (Double Flow)	FXCQ-MVE9																	
Ceiling Mounted Cassette (Single Flow)	FXEQ-AV36																	
Slim Ceiling Mounted Duct (Standard Series)	FXDQ-PDV (with drain pump)																	
	FXDQ-PDVT (without drain pump)		(700mm width type)															
	FXDQ-NDV (with drain pump)																	
	FXDQ-NDVT (without drain pump)		(900 / 1100mm width type)															
Slim Ceiling Mounted Duct (Compact Series)	FXDQ-SPV1																	
Middle Static Pressure Ceiling Mounted Duct	FXSQ-PA2S																	
Ceiling Mounted Duct	FXMQ-PAVS																	
	FXMQ-MVES																	
Outdoor-Air Processing Unit	FXMQ-MFV1																	
4-Way Flow Ceiling Suspended	FXUQ-AVEB																	
Ceiling Suspended	FXHQ-MAVS																	
Wall Mounted	FXAQ-PVES																	
Floor Standing	FXLQ-MAVE8																	
Concealed Floor Standing	FXNQ-MAVE8																	
Floor Standing Duct	FXVQ-NY1																	
	FXVQ-NY16 (high static pressure type)																	
Clean Room Air Conditioner	FXBQ-PVE																	
	FXBPQ-PVE																	
Heat Reclaim Ventilator with DX-Coil and Humidifier	VKM-GA(M)V1		Airflow rate 500-1000 m³/h															
Heat Reclaim Ventilator	VAM-GJVE		Airflow rate 150-2000 m³/h															
Air Handling Unit	AHUR		Page 55															

Residential indoor units with connection to BP units

Type	Model Name	Rated Capacity (kW)	25	35	50	60	71
			2.5	3.5	5.0	6.0	7.1
			Capacity Index	25	35	50	60
Slim Ceiling Mounted Duct	FDKS-EAVMB VRT	(700 mm width type)	●	●			
	FDKS-C(A)VMB VRT	(900/1,100 mm width type)	●	●	●	●	
Wall Mounted	FTKJ-NVMW VRT		●	●	●		
	FTKJ-NVMS VRT		●	●	●		
	FTKS-DVM VRT		●	●			
	FTKS-BVMA VRT				●		
	FTKS-FVM VRT				●	●	●

Note: BP units are necessary for residential indoor units. Only single outdoor unit (RXQ6-20AYM) can be connected.

VRV indoor units combine with residential indoor units in one system.

VRV indoor unit system



Max. **64** indoor units

- If a system has indoor units subject to both VRT smart and VRT control, the system is operated under VRT control.
- If a system has both outdoor-air processing air conditioners and outdoor-air processing type indoor units, VRT smart control and VRT control are disabled.

Mixed residential and VRV indoor unit system



Max. **32** indoor units

- BP units are necessary for residential indoor units. Only single outdoor unit (RXQ6-20AYM) can be connected.
- If a system has both residential indoor units and **VRV** indoor units, the system is operated under VRT control.

Residential indoor unit system



Max. **32** indoor units

- BP units are necessary for residential indoor units. Only single outdoor unit (RXQ6-20AYM) can be connected.
- If a system has only residential indoor units, the system is operated under VRT control.

Indoor Unit Lineup

Daikin offers a wide range of indoor units includes both **VRV** and residential models responding to variety of needs of our customers that require air-conditioning solutions.

VRV indoor units

Ceiling Mounted Cassette
(Round Flow with Sensing) Type

New FXFSQ-AVS



Presence of people and floor temperature can be detected to provide comfort and energy savings.



Ceiling Mounted Cassette
(Round Flow) Type

New FXFQ-AVS



360° airflow improves temperature distribution and offers a comfortable living environment.



Ceiling Mounted Cassette
(Compact Multi Flow) Type

FXZQ-MVES



Quiet, compact, and designed for user comfort



Ceiling Mounted Cassette
(Double Flow) Type

FXCQ-MVE9



Thin, lightweight, and easy to install in narrow ceiling spaces



Ceiling Mounted Cassette
(Single Flow) Type

New FXEQ-AV36



Slim design for flexible installation



Slim Ceiling Mounted Duct Type
(Standard Series)

New FXDQ-PDV(T)



New FXDQ-NDV(T)



Slim design, quietness and static pressure switching



Slim Ceiling Mounted Duct Type
(Compact Series)

FXDQ-SPV1



Slim and compact design for easy and flexible installation



Middle Static Pressure Ceiling
Mounted Duct Type

New FXSQ-PA2S



Middle external static pressure and slim design allow flexible installations



Ceiling Mounted Duct Type

New FXMQ-PAVS



FXMQ-MVES



High external static pressure allows flexible installations



Outdoor-Air
Processing Unit

FXMQ-MFV1



Combine fresh air treatment and air conditioning, supplied from a single system.



4-Way Flow Ceiling Suspended Type

FXUQ-AVEB

This slim and stylish indoor unit achieves optimum air distribution, and can be installed without the need for ceiling cavity



Ceiling Suspended Type

FXHQ-MAVS

Slim body with quiet and wide airflow



Wall Mounted Type

FXAQ-PVES

Stylish flat panel design harmonised with your interior décor



Floor Standing Type

FXLQ-MAVE8

Concealed Floor Standing Type

FXNQ-MAVE8

Suitable for perimeter zone air conditioning



Floor Standing Duct Type

FXVQ-NY1

FXVQ-NY16
(high static pressure type)



Large airflow type for large spaces. Flexible interior design for each tenant.

Clean Room Air Conditioner

FXBQ-PVE

FXBPQ-PVE



Suitable for hospitals and other clean spaces

Air Handling Unit

AHUR



Integrate your air handling unit in a total solution for large size spaces such as factories and large stores.

Residential indoor units with connection to BP units

Slim Ceiling Mounted Duct Type

FDKS-EAVMB

FDKS-C(A)VMB



Slim and smooth design suits your shallow ceiling

Wall Mounted Type

FTKJ-NVMW

FTKJ-NVMS



Elegant appearance with European style

Wall Mounted Type

FTKS-DVM

FTKS-BVMA

FTKS-FVM



Stylish flat panel harmonises with your interior décor

Air treatment equipment

Heat Reclaim Ventilator with DX-Coil and Humidifier

VKM-GA(M)



Heat Reclaim Ventilator

VAM-GJ



Indoor Unit Lineup

Ceiling Mounted Cassette (Round Flow with Sensing) Type

New FXFSQ-A
Round flow with sensing



Ceiling Mounted Cassette (Round Flow) Type

New FXFQ-A
ROUND FLOW



New Wide variety of decoration panels (Option)

● Designer choice has been given a boost with the increase in number of new types of decoration panels.



FXFSQ series only
Standard panel with sensing



- Black -



Designer panel



- Fresh White -



- Black -

Standard panel

New Designer panel (Option)

Close to ideal styling

— New designer panel —

<p>FLAT</p> <p>Flatter styling: Suction panel grid texture smoothed.</p>	<p>CLEAN</p> <p>Clean-cut form: Soiling is hard to see on smart-looking panel.</p>	<p>ROUND</p> <p>Subtle distinction: around suction inlets silvering is a tasteful touch.</p>
---	---	---

Decoration Panel Lineup (Option)



FXFSQ series only
Standard panel with sensing^{*1}
BYCQ125EEF (Fresh White)



Standard panel^{*2}
BYCQ125EAF (Fresh White)



Designer panel^{*2}
BYCQ125EAPF (Fresh White)



Auto grille panel^{*2}
BYCQ125EASF (Fresh White)



FXFSQ series only
Standard panel with sensing^{*1}
BYCQ125EEK (Black)



Standard panel^{*2}
BYCQ125EAK (Black)

*1.Sensing function is applicable when sensing panel is installed.

*2.These panels do not contain the sensing function.



Specifications

Ceiling Mounted Cassette (Round Flow with Sensing) Type

MODEL		FXFSQ25AVS	FXFSQ32AVS	FXFSQ40AVS	FXFSQ50AVS	FXFSQ63AVS	FXFSQ80AVS	FXFSQ100AVS	FXFSQ125AVS	FXFSQ140AVS
Power supply		1-phase, 220-240 V/220-230 V, 50/60 Hz								
Cooling capacity	Btu/h	9,600	12,300	15,400	19,100	24,200	30,700	38,200	47,800	54,600
	kW	2.8	3.6	4.5	5.6	7.1	9.0	11.2	14.0	16.0
Power consumption		0.028		0.035	0.038	0.061	0.092	0.144	0.170	0.194
Casing		Galvanised steel plate								
Airflow rate (H/HM/M/ML/L)	m ³ /min	13/12.5/11.5/11/10		17/13.5/12.5/12/11	23/20.5/19/14.5/11	23.5/21/20/16/13.5	24.5/22/20.5/20/15	33.5/30.5/27/23.5/21	34.5/31.5/28.5/25.5/23	35.5/32.5/29.5/26.5/23
	cfm	459/441/406/388/353		600/477/441/424/388	812/724/671/512/388	830/741/706/565/477	865/777/724/706/530	1,183/1,077/853/830/741	1,218/1,112/1,006/900/812	1,253/1,147/1,041/935/812
Sound level (H/HM/M/ML/L)		30/29.5/28.5/28/27		35/29.5/29/28/27	38/35/34.5/29.5/27	38/36/35.5/31.5/28	39/37/36/35.5/31	44/41/38/35/33	45/42.5/39.5/37/35	46/43.5/40.5/38/35
Dimensions (H×W×D)		256×840×840						298×840×840		
Machine weight		19			24	22	25		26	
Piping connections	Liquid (Flare)	φ 6.4				φ 9.5				
	Gas (Flare)	φ 12.7				φ 15.9				
	Drain	VP25 (External Dia, 32/Internal Dia, 25)								

Ceiling Mounted Cassette (Round Flow) Type

MODEL		FXFQ25AVS	FXFQ32AVS	FXFQ40AVS	FXFQ50AVS	FXFQ63AVS	FXFQ80AVS	FXFQ100AVS	FXFQ125AVS	FXFQ140AVS
Power supply		1-phase, 220-240 V/220-230 V, 50/60 Hz								
Cooling capacity	Btu/h	9,600	12,300	15,400	19,100	24,200	30,700	38,200	47,800	54,600
	kW	2.8	3.6	4.5	5.6	7.1	9.0	11.2	14.0	16.0
Power consumption		0.029		0.036	0.040	0.063	0.096	0.158	0.178	0.203
Casing		Galvanised steel plate								
Airflow rate (H/HM/M/ML/L)	m ³ /min	13/12.5/11.5/11/10		17/13.5/13/12/11	18/17/13.5/12.5/11	21/20/16/15/13.5	22.5/21.5/21/20/15	32/29/26/23/21	33/30.5/28/25.5/21	35.5/32.5/29.5/26.5/23
	cfm	459/441/406/388/353		600/477/459/424/388	635/600/477/441/388	741/706/565/530/477	794/759/741/706/530	1,130/1,024/918/812/741	1,165/1,077/988/900/741	1,253/1,147/1,041/935/812
Sound level (H/HM/M/ML/L)		30/29.5/28.5/28/27		35/29.5/29/28/27	35/33.5/29.5/28.5/27	36/35.5/31.5/31/28	37/36.5/36/35.5/29.5	43/40.5/37.5/35/33	44/41.5/39/36.5/33	46/43.5/40.5/38/35
Dimensions (H×W×D)		256×840×840						298×840×840		
Machine weight		19			22		25		26	
Piping connections	Liquid (Flare)	φ 6.4				φ 9.5				
	Gas (Flare)	φ 12.7				φ 15.9				
	Drain	VP25 (External Dia, 32/Internal Dia, 25)								

Note: Specifications are based on the following conditions;

- Cooling: Indoor temp.: 27°CDB, 19°CWB, Outdoor temp.: 35°CDB, Equivalent piping length: 7.5 m, Level difference: 0 m.
- Capacity of indoor unit is only for reference. Actual capacity of indoor unit is based on the total capacity index. (See Engineering Data Book for details.)
- Sound level: Anechoic chamber conversion value, measured at a point 1.5 m downward from the unit centre.

During actual operation, these values are normally somewhat higher as a result of ambient conditions.

Decoration Panel (Option)

		Round Flow with Sensing Type		Round Flow Type		
		FXFSQ-A		FXFQ-A		
Standard panel with sensing	Model	BYCQ125EEF (Fresh White) / BYCQ125EEK (Black)				—
	Dimensions(H×W×D)	mm		50×950×950		—
	Weight	kg		5.5		—
Standard panel	Model	BYCQ125EAF (Fresh White) / BYCQ125EAK (Black)				—
	Dimensions(H×W×D)	mm		50×950×950		—
	Weight	kg		5.5		—
Designer panel	Model	BYCQ125EAPF (Fresh White)				—
	Dimensions(H×W×D)	mm		97×950×950		—
	Weight	kg		6.5		—
Auto grille panel	Model	BYCQ125EASF (Fresh White)				—
	Dimensions(H×W×D)	mm		105×950×950		—
	Weight	kg		8		—

Function List

		Round Flow with Sensing Type		Round Flow Type	
		FXFSQ-A		FXFQ-A	
Remote controller	Wired	BRC1E63		BRC1E63	
	Wireless	—		BRC7M635F	
Dual sensors *1		○		—	
Direct airflow *1		○		—	
Sensing sensor low mode *1		○		—	
Sensing sensor stop mode *1		○		—	
Circulation airflow		○		○	
Individual airflow direction control		○		○	
Switchable 5 step fan speed		○		○	
Auto airflow rate		○		○	
Auto swing		○		○	
Swing pattern selection		○		○	
High ceiling application		○		○	

*1. Applicable when sensing panel is installed.

Indoor Unit Lineup

Daikin Advanced Sensing Functions^{*1,2} **FXFSQ series only**

Dual Sensors^{*1}

*1. Applicable when sensing panel (BYCQ125EEF/EEK) is installed.
*2. Applicable when wired remote controller BRC1E63 is used.

Dual sensors and individual airflow direction control automatically provide optimal control of airflow.

Infrared presence sensor

The sensor detects the presence of people in each of the 4 areas.

Ceiling height	2.7m	3.5m	4.0m
Detection range (diameter) ^{*3}	approx. 8.5m	approx. 11.5m	approx. 13.5m

*3. The infrared presence sensor detects 80cm above the floor.

Infrared floor sensor

The sensor detects the floor temperature and automatically adjusts operation of the indoor unit to reduce the temperature difference between the ceiling and the floor.

Ceiling height	2.7m	3.5m	4.0m
Detection range (diameter) ^{*4}	approx. 11m	approx. 14m	approx. 16m

*4. The infrared floor sensor detects at the floor surface.

Standard range for infrared presence sensor *

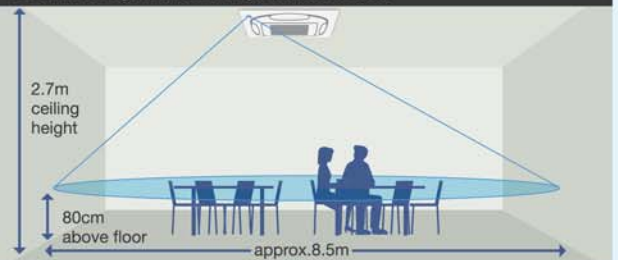

[Concerning infrared presence sensor]
- People are detected by large movements such as the motion of people walking at a certain distance away from sensor.
- Human detection is not possible for blind areas of sensor.
[Concerning infrared floor sensor]
- The detected temperature may sometimes be affected by a heat source, window, or device emitting heat in the detection range.

Auto Airflow Function^{*5}

*5. Airflow direction should be set to "Auto".

New Direct Airflow (default: OFF) **Cooling** **Dry**

When human presence is not detected



Optimal air direction by "Auto"

When human presence is detected



Optimal air direction by "Auto" **Swing (narrow)**

• With "Auto" airflow direction mode, flaps are controlled to deliver optimal airflow when the room is unoccupied.

• When presence is detected, air direction is set to "Swing (narrow)" to deliver cool air to users.



Ceiling Mounted Cassette
(Round Flow with Sensing) Type **New FXFSQ-A**

Comfort and Energy Saving Preventing Overcooling^{*6}

^{*6}Airflow direction and airflow rate should be set to "Auto".

Floor temperature is detected and overcooling prevented. **Cooling**

Without sensing function

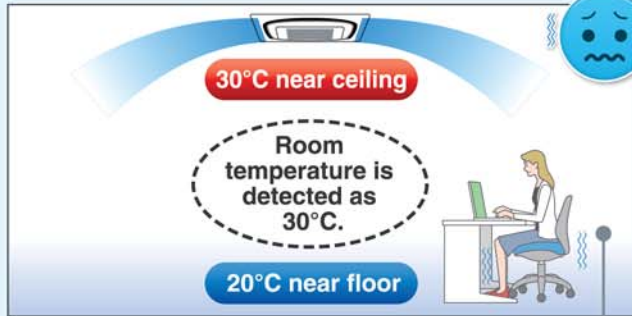

Area around feet gets too cold because the air conditioner continues until the temperature near the ceiling reaches the set temperature.

With sensing function

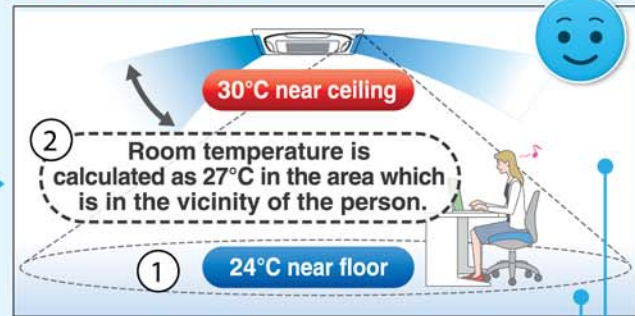

The floor temperature, which is lower than near the ceiling, is detected.

Automatic control using the temperature near the person as the room temperature.

Energy savings

The temperature near the person is automatically calculated by detecting the temperature of the floor. Energy is saved because the area around the feet does not get too cold.

Sensing Sensor Functions^{*7,8,9}

^{*7}. Applicable when sensing panel (BYCQ125EEF/EEK) is installed.

^{*8}. These functions are not available when using the group control system.

^{*9}. User can set these functions with remote controller.

Sensing sensor low mode (default: OFF)

When there are no people in a room, the set temperature is shifted automatically.

- The system automatically saves energy by detecting whether or not the room is occupied. The set temperature is shifted automatically if the room is unoccupied.

Operation is reduced in places where there are no people.

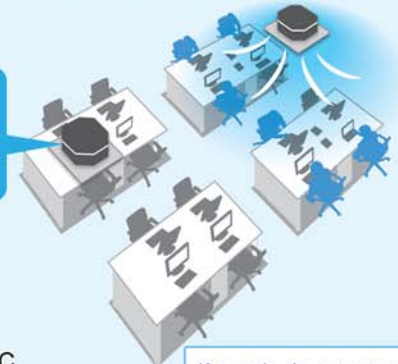

Example

- Cooling set temperature: 26°C
- Shift temperature: 1.0°C
- Shift time: 30 min.
- Limit cooling set temperature: 30°C

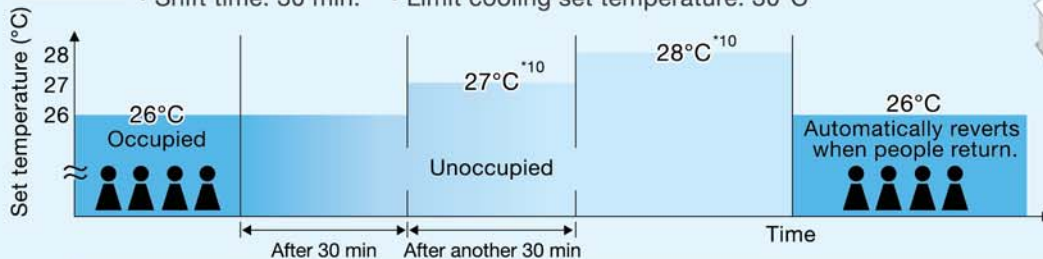

If people do not return, the air conditioner will raise the set temperature 1°C every 30 minutes and then operate at 30°C.

Shift temperature and time can be selected from 0.5 to 4°C in 0.5°C increments and 15, 30, 45, 60, 90 or 120 minutes respectively with remote controller.

^{*10}. On basic screen of remote controller, set temperature does not change.

Sensing sensor stop mode (default: OFF)

When there are no people in a room, the system stops automatically.^{*11,12}

- The system automatically saves energy by detecting whether or not the room is occupied.
- Based on preset user conditions, the system automatically stops operation if the room is unoccupied.

Absent stop time can be selected from 1 to 24 hrs in 1 hr increments with remote controller.

^{*11}. Please note that upon re-entering the room, the air conditioner will not switch on automatically.

^{*12}. To protect the machine, the standby system may operate temporarily.



Indoor Unit Lineup

New Circulation Airflow^{*1}

*1. Applicable when wired remote controller BRC1E63 is used.

Airflow until now had areas that were either too cool or not cool enough.



- Problem 1**
Hot outdoor air entering through windows and walls causes these areas to become hot.
- Problem 2**
Cool air accumulating directly underneath causes cold air pockets at floor level.
- Problem 3**
Airflow blowing directly on people causes discomfort for people in the room.
- Problem 4**
Quick descent of cool air causes insufficient cooling for corners of the room.

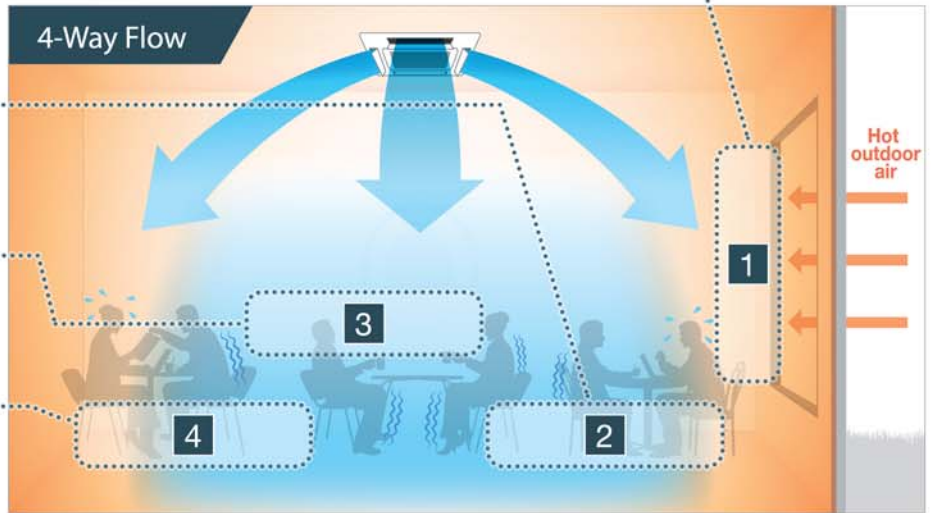

Circulation airflow cools the entire room to deliver comfort that never feels cold.

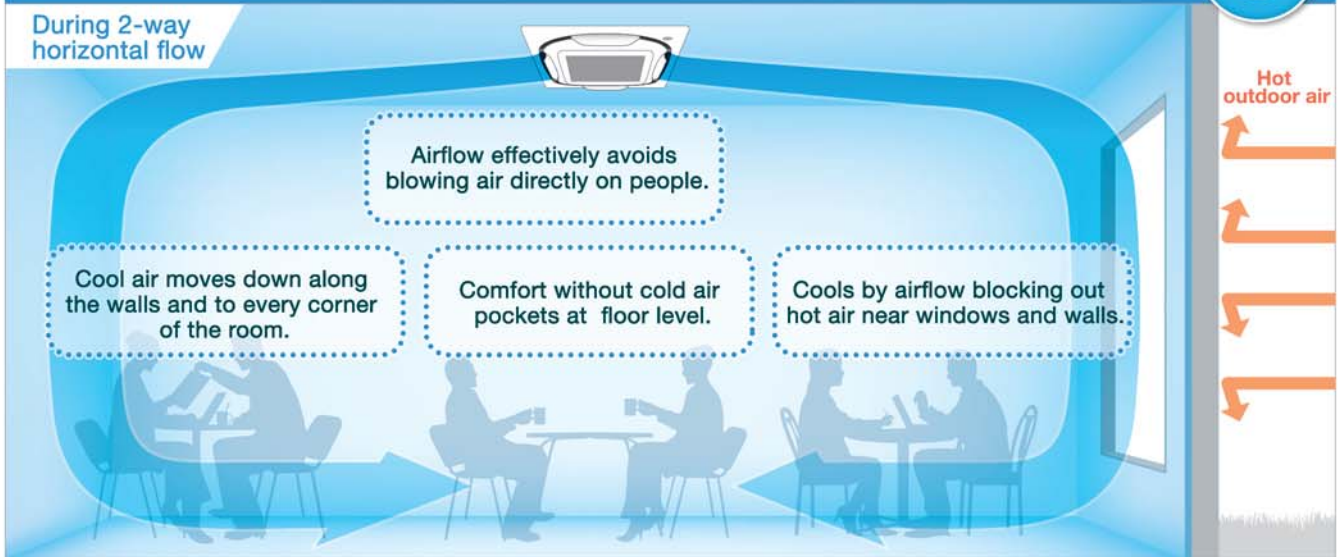

Configurations of Circulation Airflow

Cools the entire room to deliver comfort that never feels cold.

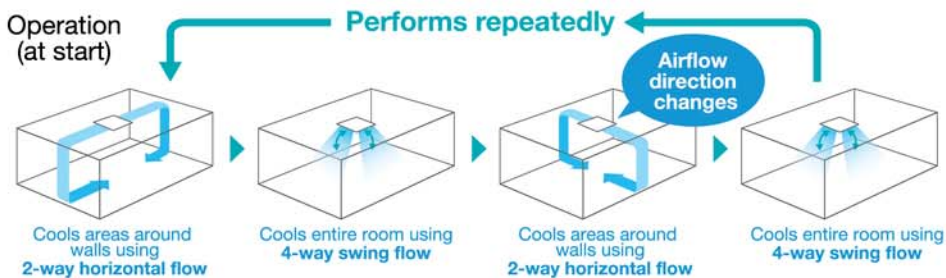

When the set temperature is reached, normal operation (all-round flow) begins.

Note: Results may vary depending on equipment conditions, room size, and distance from indoor unit to walls.



Ceiling Mounted Cassette
(Round Flow with Sensing) Type

New **FXFSQ-A**

Ceiling Mounted Cassette
(Round Flow) Type

New **FXFQ-A**

Comfort to the Entire Room with Even Temperatures and No Cold Air Pockets at Floor Level

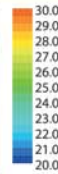
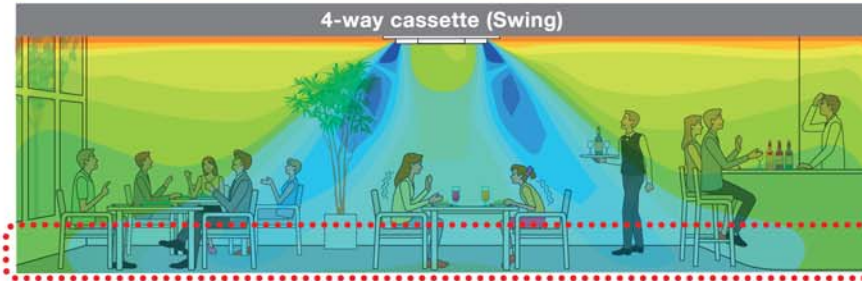

Comparison Conditions

- Room size:
Width 7.5m x depth 7.5m
x height 2.6m
- Indoor unit capacity: 80 class
- Outdoor air temperature: 35°C
- Airflow rate and air direction:
high / swing

Areas at floor level are cold while areas around walls are hot.

Approx. 5% energy^{*2} savings by reducing uneven temperatures

^{*2}. Calculated under the following comparison conditions: When the average temperature at a height of 0.6m above the floor reaches set temperature. (26°C)

Full comfort is provided with no cold feet.

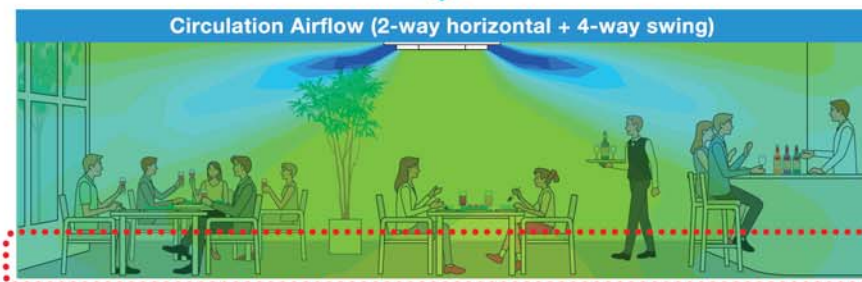

Three Technologies That Achieved Circulation Airflow

1 Use of new wide flaps (Straight)

With new, larger flaps, a straighter trajectory for airflow was achieved.

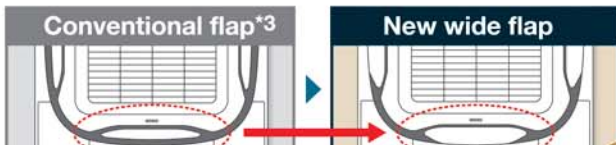

^{*3}. FXFQ-S model

New wide flap construction inhibits ceiling dirt and grime.

By tapering both flap ends, the airflow that causes dirty ceilings is directed downward.

Approx. doubled

2 Optimizing airflow angle (Horizontally)

The airflow angle was made more horizontal.

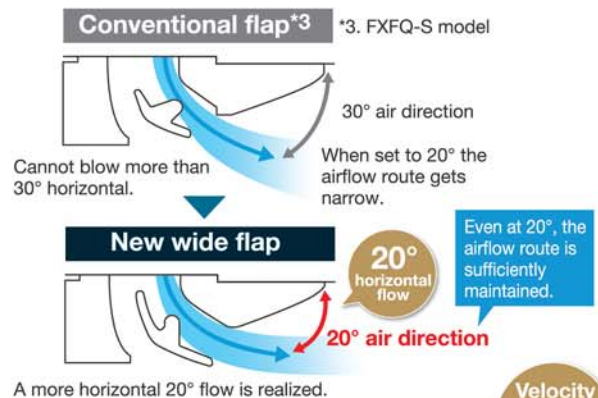

Conventional flap^{*3}

^{*3}. FXFQ-S model

30° air direction

Cannot blow more than 30° horizontal.

When set to 20° the airflow route gets narrow.

20° horizontal flow

Even at 20°, the airflow route is sufficiently maintained.

A more horizontal 20° flow is realized.

Velocity 10% increase!

3 Increased velocity in 2-way flow (Strongly)

Velocity increased by making 2-way flow. Powerful airflow was realized.

^{*4}. Other 2 outlets are controlled by changing the flap direction (angle) to suppress airflow volume.

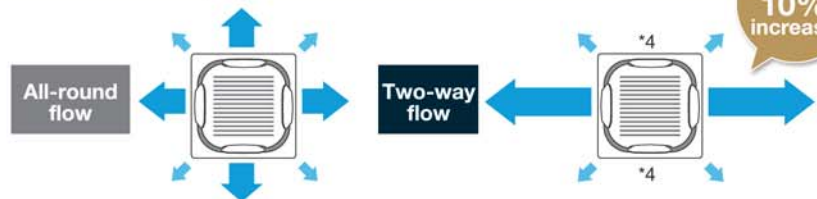

Things to remember when using circulation airflow

Main points for use

- Effectiveness may differ according to room conditions, room size, and distance to walls.
- Airflow operation differs when using the designer panel. (Operation repeatedly switches from 3-way horizontal flow to 4-way downward flow [swing] to 2-way horizontal flow to 4-way downward flow [swing].)
- Circulation airflow functions during connection with wired remote controller. (BRC1E63). However, use is not possible for the following conditions:
 - When a sealing material of air discharge outlet and branch ducts are used;
 - When individual airflow setting is selected;
 - When using group control other than round flow.

Installation conditions

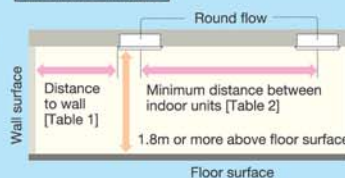

[Table 1]

Distance to wall from indoor unit

Indoor unit capacity	FXF(S)Q 25-50	FXF(S)Q 63/80	FXF(S)Q 100-140
Maximum distance	1.5m-4m	1.5m-5m	1.5m-7m

[Table 2]

Minimum distance between indoor units

Indoor unit capacity	FXF(S)Q 25-50	FXF(S)Q 63/80	FXF(S)Q 100-140
Minimum distance	4m or more	5m or more	7m or more

Indoor Unit Lineup

New Individual Airflow Direction Control^{*1}

*1. Applicable when wired remote controller BRC1E63 is used.

Comfortable air conditioning for all room layouts and conditions

Airflow direction can be individually adjusted for each air discharge outlet to deliver optimal air distribution.

Easy setting is possible with a wired remote controller.



New BRC1E63

Individual Setting List		
Outletmark	Air direc.	Indiv.
<input type="checkbox"/>	Position 0	ON
<input type="checkbox"/>	Auto	OFF
<input type="checkbox"/>	Position 4	ON
<input type="checkbox"/>	Swing	ON

Remote controller screen

There are identification marks near the air outlets.

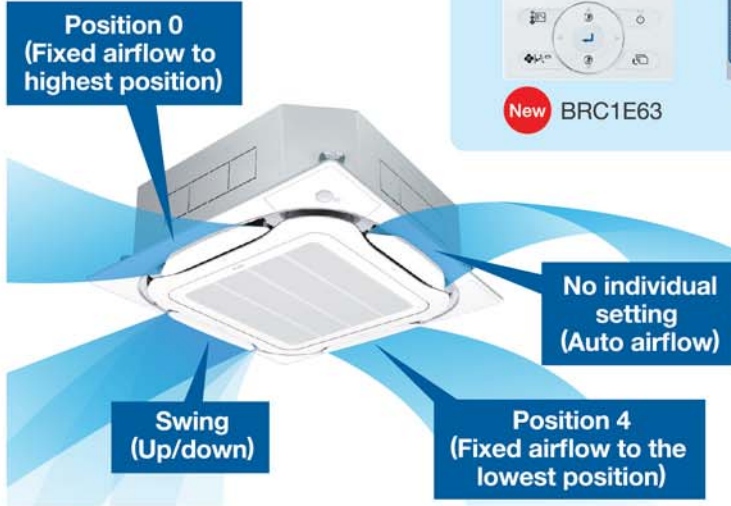
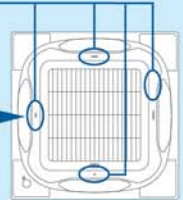

Individual airflow settings

- No individual setting (Auto airflow)
- Position 0 (Highest point)
- Position 1
- Position 2
- Position 3
- Position 4 (Lowest point)
- Swing

Individual settings are possible as stated above.

When individual airflow is selected, airflow direction can be adjusted to room layout.

For offices

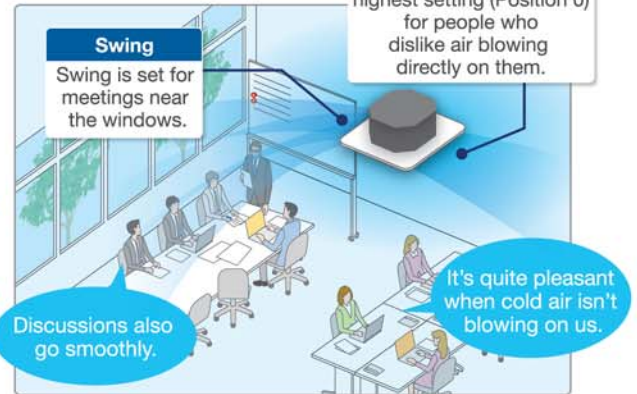
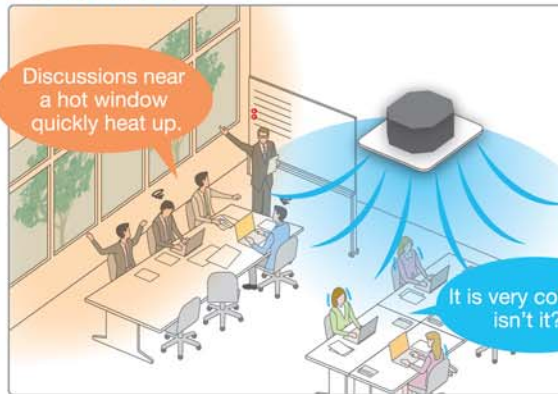

For shops and restaurant

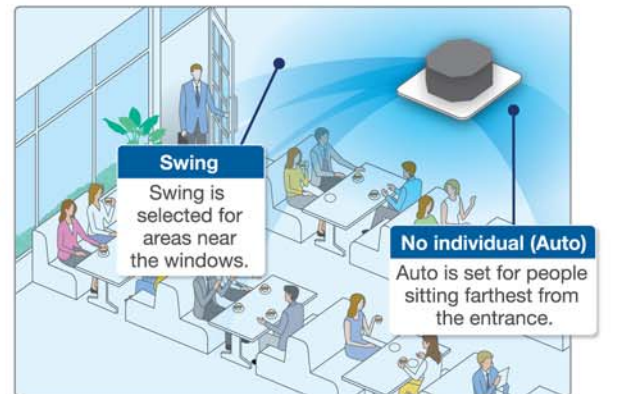
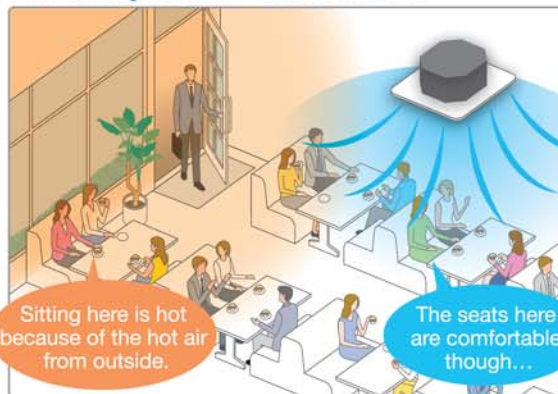



Ceiling Mounted Cassette
(Round Flow with Sensing) Type

New FXFSQ-A

Ceiling Mounted Cassette
(Round Flow) Type

New FXFQ-A

Other Functions

Comfort

360° Airflow & Selectable Airflow Pattern

Indoor unit offers 360° airflow discharges air in all directions with more uniform temperature distribution. Because air flows out from corner outlets, comfort spreads more widely.

Typical flow patterns There are a total of 18 flow patterns.

All-round flow

(E.g., installed in middle of ceiling)
4-way flow also possible.

3-way flow

(E.g., installed near a wall)

L-shaped 2-way flow

(E.g., installed in a corner)

Opposite 2-way flow

(E.g., installed in a long room)

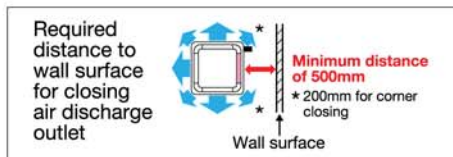

Note:

- Whatever the discharge direction, the same type of panel is used. If installing for other than all-round flow, an air discharge outlet sealing material (option) must be used to close each unused outlet.
- Operation sound increases when using 2-way or 3-way flow.
- Designer panel cannot operate 2-way and 3-way flow.

Optimal comfort and convenience assured by 3 air discharge modes

Air direction	Standard setting ¹	Draft prevention setting (field setting)	Ceiling soiling prevention setting ² (field setting)
Desired situation	For gentle drafts.	When drafts are unwanted.	For shops with light coloured ceilings that must be kept spotless.
Auto-swing			
5-level air direction setting			
Auto air direction control		The air direction is set automatically to the memorised position of the previous air direction.	

Note:

¹Air direction is set to the standard position when the unit is shipped from the factory. The position can be changed from the remote controller.

²Closing of the corner discharge outlets is recommended.

Switchable fan speed: 5 steps and Auto

Control of airflow rate has been improved from 3-step to 5-step. Auto airflow rate is newly available.

Suitable for high ceilings

Even in spaces with high ceilings, a comfortable airflow is carried down to the floor level.

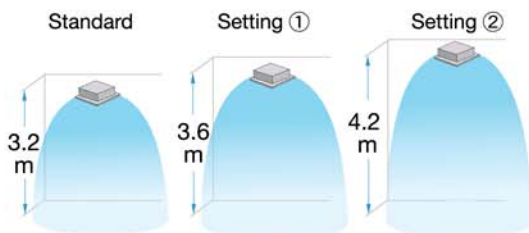

When all round flow is selected, ceilings up to 4.2 m in height can be accommodated. (FXF(S)Q100-140A)

■ Criteria for ceiling height and number of air discharge outlets (Ceiling height is reference value)

		Number of air discharge outlets used							
		FXF(S)Q25-80A				FXF(S)Q100-140A			
		All round flow	4-way flow	3-way flow	2-way flow	All round flow	4-way flow	3-way flow	2-way flow
Ceiling height	Standard	2.7 m	3.1 m	3.0 m	3.5 m	3.2 m	3.4 m	3.6 m	4.2 m
	High ceiling ①	3.0 m	3.4 m	3.3 m	3.8 m	3.6 m	3.9 m	4.0 m	4.2 m
	High ceiling ②	3.5 m	4.0 m	3.5 m	—	4.2 m	4.5 m	4.2 m	—

Note:

- The aforementioned is for standard panels. See the installation manual for designer panels.
- Factory settings are for standard ceiling height and all-round flow.
- High ceiling settings (1) and (2) are set with the remote controller by field setting.
- High-efficiency filters are not available for high ceiling applications.

Indoor Unit Lineup

Quick and Easy Installation

Lightweight

All models can be installed without using a lifter.

Installable in tight ceiling spaces

Standard panel

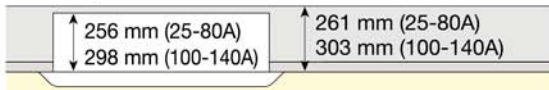

Designer panel

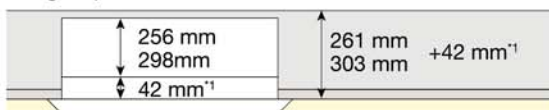

*1. Body height (ceiling required space) is 42 mm higher than standard panel.

Auto grille panel

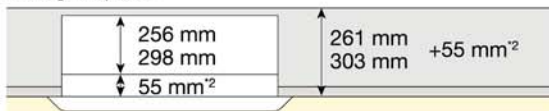

*2. Body height (ceiling required space) is 55 mm higher than standard panel.

*When the ceiling space is limited, an optional panel spacer is available. (See page 87)

Easy height adjustment

Each corner of the unit has an adjuster pocket that lets you easily adjust the unit's suspended height.

Note:

If the wireless remote controller is installed, a signal receiver unit is housed in one of the adjuster pockets.

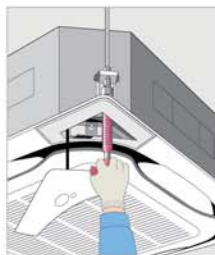

Temporary placement of control box lid

Because the control box lid can be temporarily hung on the unit, there is no need to climb down the stepladder to retrieve it.

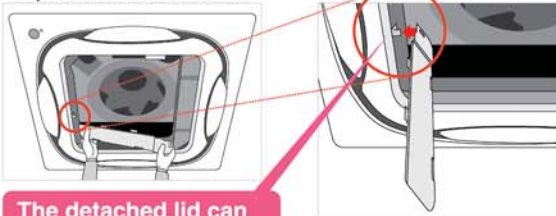

The detached lid can be hung on a hook.

Installed in any direction

Since the orientation of the suction grille can be adjusted after installing, the direction of the suction grille lines can be unified when multiple units are installed.

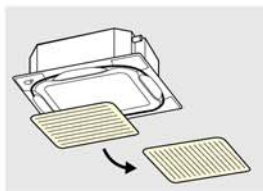

Easy hanging

Washer fixing plates secure washers in place and prevent washers from falling for easy installation.



Easy removal of corner cover

It is possible to easily remove without use of screws or tools.



Ease in temporary hanging of decoration panel

In addition to the temporary hanging fixtures in 2 places normally used, corner part mounting fixtures in 4 places are provided.

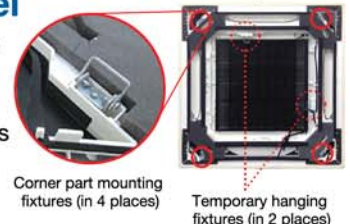

Corner part mounting fixtures (in 4 places)

Temporary hanging fixtures (in 2 places)

Drain pump

Equipped as standard accessory with 850 mm lift.

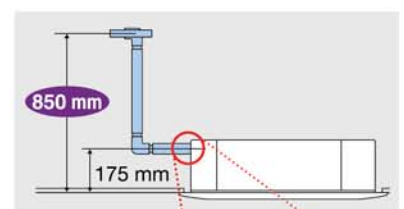

Transparent drain socket



■ Hanging height adjustment

Because the configuration of the hanger bracket changed, the dimensions from the ceiling to the hanger bracket also change during height adjustment for indoor unit.

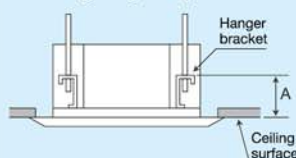

	A Dimensions
Standard panel	125-130mm
Designer panel	167-172mm
Auto grille panel	180-185mm
Chamber option*+ standard panel	175-180mm

*High-efficiency filter, ultra long-life filter, and fresh air intake

Ceiling Mounted Cassette
(Round Flow with Sensing) Type

New **FXFSQ-A**

Ceiling Mounted Cassette
(Round Flow) Type

New **FXFQ-A**

Easy Maintenance

Drain pan and drain water check

The condition of the drain pan and drain water can be checked by removing the suction grille and drain plug.

Note: For inquiries concerning auto grille panel installations, please contact your local dealer or Daikin representative.



24 mm diameter drain outlet

The drain outlet allows insertion of a finger or dental mirror for inspection of the internal cleanliness of the drain pan. Removal of the suction panel enables access.

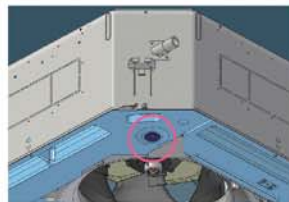

Auto grille panel (option)

Grille and air filter cleaning can be performed without need for a stepladder by lowering the grille.

A dedicated remote controller for the auto grille panel (BRC16A2) is included.
Operation is not possible using BRC1E63.

The drop length corresponds to ceiling height and can be set for 8 different levels.

Ceiling Height Standard (m)	Drop Length
2.4	1.2
2.7	1.6
3.0	2.0
3.5	2.4
3.8	2.8
4.2	3.1
4.5	3.5
5.0*	3.9

*Airflow range is up to 4.5m.
Please refer to "criteria for ceiling height and number of air discharge outlets" on page 28.



Ultra long-life filter (option)

See page 87

Maintenance is not required in normal shops or offices for up to four years.

Cleanliness

Silver ion anti-bacterial drain pan

A built-in antibacterial treatment that uses silver ion in the drain pan prevents the growth of slime, bacteria, and mould that cause odours and clogging.

(The lifespan of a silver ion cartridge depends on the usage environment, but should be changed once every two to three years.)



Non-flocking flaps

Flaps can be detached without use of tools. Condensation does not easily form and dirt does not cling to non-flocking flaps. They are easy to clean.



Filter has anti-mould and antibacterial treatment

Prevents mould and microorganisms growing out of the dust and moisture that adheres to the filters.

Indoor Unit Lineup

Ceiling Mounted Cassette (Compact Multi Flow) Type FXZQ-M

Quiet, compact, and designed for user comfort



● Comfortable airflow

1 Wide discharge angle: 0° to 60°

● Auto swing

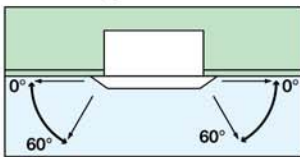

● Fixed angles: 5 levels

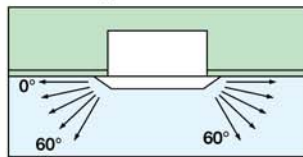

*Angles can be also set on site to prevent drafts (0°-35°) or soiling of the ceiling (25°-60°), other than standard setting (0°-60°).

2 2-, 3-, and 4-way airflow patterns are available, enabling installation in the corner of a room.

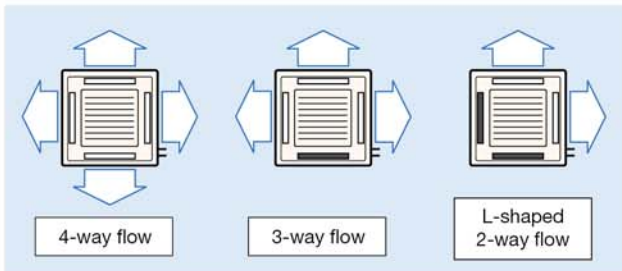

*For 3-way or 2-way flow installation, the sealing material for air discharge outlet (option) must be used to close each unused outlet.

● Low operation sound level

● Dimensions correspond with 600 mm X 600 mm architectural module ceiling design specifications.

● Drain pump is equipped as standard accessory with 750 mm lift.

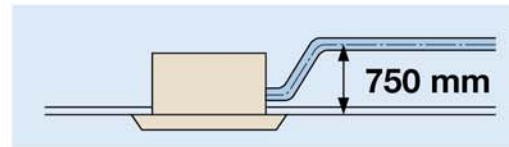

Specifications

MODEL		FXZQ20MVES	FXZQ25MVES	FXZQ32MVES	FXZQ40MVES	FXZQ50MVES
Power supply		1-phase, 220-240 V/220 V, 50/60 Hz				
Cooling capacity	Btu/h	7,500	9,600	12,300	15,400	19,100
	kW	2.2	2.8	3.6	4.5	5.6
Power consumption	kW	0.073		0.076	0.089	0.115
Casing		Galvanised steel plate				
Airflow rate (H/L)	m ³ /min	9/7		9.5/7.5	11/8	14/10
	cfm	318/247		335/265	388/282	493/353
Sound level (H/L)	230 V, 50 Hz- 240 V, 50 Hz	30/25-32/26		32/26-34/28	36/28-37/29	41/33-42/35
Dimensions (H×W×D)	mm	286×575×575				
Machine weight	kg	18				
Piping connections	Liquid (Flare)	φ6.4				
	Gas (Flare)	φ12.7				
	Drain	VP20 (External Dia, 26/Internal Dia, 20)				
Panel (Option)	Model	BYFQ60B3W1				
	Colour	White (6.5Y9.5/0.5)				
	Dimensions(H×W×D)	mm	55×700×700			
	Weight	kg	2.7			

Note: Specifications are based on the following conditions;

- Cooling: Indoor temp.: 27°CDB, 19°CWB, Outdoor temp.: 35°CDB, Equivalent piping length: 7.5 m, Level difference: 0 m.
 - Capacity of indoor unit is only for reference. Actual capacity of indoor unit is based on the total capacity index. (See Engineering Data Book for details.)
 - Sound level: Anechoic chamber conversion value, measured at a point 1.5 m downward from the unit centre.
- During actual operation, these values are normally somewhat higher as a result of ambient conditions.

Ceiling Mounted Cassette (Double Flow) Type FXCQ-M

Thin, lightweight, and easy to install in narrow ceiling spaces



- The thin unit (only 305 mm high) can be installed in a ceiling space as narrow as 350 mm. All models feature a compact design with a depth of only 600 mm.

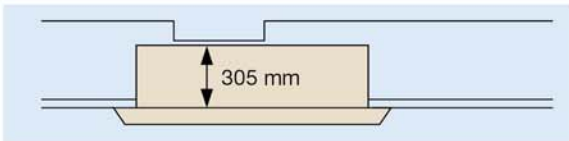

(When a high-efficiency filter is attached, the unit's height is 400 mm.)

- Low operation sound level
- Designed with higher airflow suitable for high ceiling application up to 3 metres.
- Providing 2 different settings of standard and ceiling soiling prevention, the auto swing mechanism realises even distribution of airflow and room temperature.

- Drain pump is equipped as standard accessory with 600 mm lift.

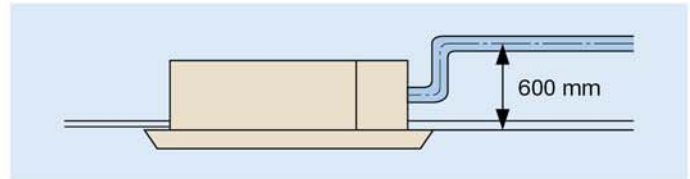

- Two types of optional high-efficiency filter are available (65% and 95%, colourimetric method).
- A long-life filter (maintenance free up to one year*) is equipped as standard accessory.
* 8 hr/day, 25 day/month. For dust concentration of 0.15 mg/m³
- Major maintenance work can be performed by removing the panel. A flat-type suction grille and a detachable blade make cleaning easy.

Specifications

MODEL		FXCQ20MVE9	FXCQ25MVE9	FXCQ32MVE9	FXCQ40MVE9	FXCQ50MVE9	FXCQ63MVE9	FXCQ80MVE9	FXCQ125MVE9	
Power supply		1-phase, 220-240 V/220 V, 50/60 Hz								
Cooling capacity	Btu/h	7,500	9,600	12,300	15,400	19,100	24,200	30,700	47,800	
	kW	2.2	2.8	3.6	4.5	5.6	7.1	9.0	14.0	
Power consumption	kW	0.077	0.092	0.092	0.130	0.130	0.161	0.209	0.256	
Casing		Galvanised steel plate								
Airflow rate (H/L)	m ³ /min	7/5	9/6.5	9/6.5	12/9	12/9	16.5/13	26/21	33/25	
	cfm	247/177	318/230	318/230	424/318	424/318	582/459	918/741	1,165/883	
Sound level (H/L)	220 V	32/27	34/28	34/28	34/29	34/29	37/32	39/34	44/38	
	240 V	34/29	36/30	36/30	37/32	37/32	39/34	41/36	46/40	
Dimensions (H×W×D)	mm	305×775×600	305×775×600	305×775×600	305×990×600	305×990×600	305×1,175×600	305×1,665×600	305×1,665×600	
Machine weight	kg	26.0	26.0	26.0	31.0	32.0	35.0	47.0	48.0	
Piping connections	Liquid (Flare)	φ6.4	φ6.4	φ6.4	φ6.4	φ6.4	φ9.5	φ9.5	φ9.5	
	Gas (Flare)	φ12.7	φ12.7	φ12.7	φ12.7	φ12.7	φ15.9	φ15.9	φ15.9	
	Drain	VP25 (External Dia, 32/Internal Dia, 25)								
Panel (Option)	Model	BYBC32G-W1			BYBC50G-W1			BYBC63G-W1	BYBC125G-W1	
	Colour	White (10Y9/0.5)								
	Dimensions(H×W×D)	mm	53×1,030×680	53×1,030×680	53×1,030×680	53×1,245×680	53×1,245×680	53×1,430×680	53×1,920×680	53×1,920×680
	Weight	kg	8.0	8.0	8.0	8.5	8.5	9.5	12.0	12.0

Note: Specifications are based on the following conditions;

- Cooling: Indoor temp.: 27°CDB, 19°CWB, Outdoor temp.: 35°CDB, Equivalent piping length: 7.5 m, Level difference: 0 m.
- Capacity of indoor unit is only for reference. Actual capacity of indoor unit is based on the total capacity index. (See Engineering Data Book for details.)
- Sound level: Anechoic chamber conversion value, measured at a point 1.5 m downward from the unit centre.
During actual operation, these values are normally somewhat higher as a result of ambient conditions.

Indoor Unit Lineup

Ceiling Mounted Cassette (Single Flow) Type

Slim design for flexible installation

The body features a compact design with a height of just 200 mm and depth 470 mm, making the installation possible in tight ceiling spaces.

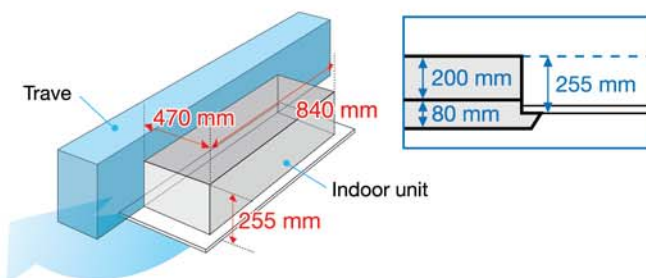

The swinging of horizontal and vertical swing flaps can be adjusted freely with the remote controller, providing 3D airflow to every corner of the room.

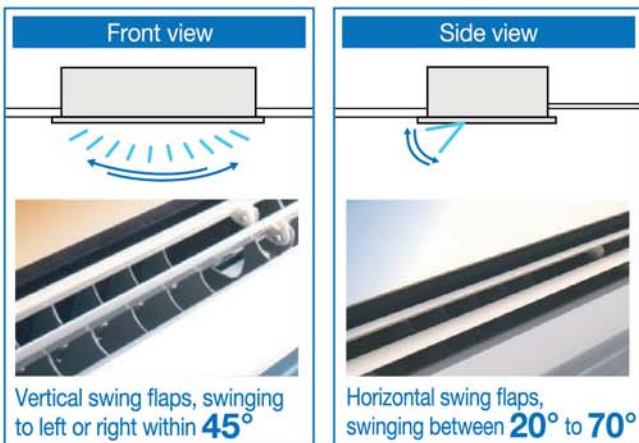

Control of airflow rate can be selected from 5-step control and quiet operation mode, which provides comfortable airflow.

IDC motor is adopted both in the fan and drain pump of the indoor unit, not only enhancing the energy saving performance, but also reducing the operating sound and the vibration incurred to the unit.

While creating a cozy indoor environment, the unit can prevent the suspended ceiling from being soiled by adjusting its louvre angle.



The novel smooth panel design makes dust difficult to accumulate, thus causing the cleaning more conveniently.



Drain pump is equipped as standard accessory with 850 mm lift.

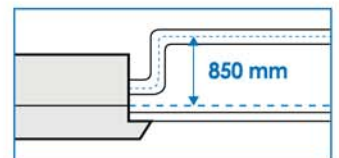

Servicing of common parts such as the control box etc. can be performed easily only with the suction panel removed.

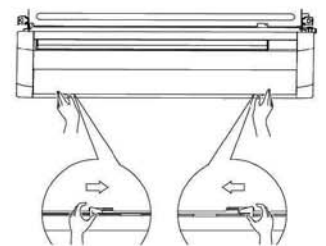

New Remote Controller (Option)

■ Wireless Remote Controller

- IStylish new design giving more satisfaction of ownership
- IComes in white colour
- IUser-friendly buttons with new functions such as 2 flaps control, 5-step airflow control, automatic airflow
- IBack light function helps operating in dark rooms



BRC4M63



The LCD panel lights up during use, making the remote controller easy to handle even in dark.

■ Navigation Remote Controller (Wired Remote Controller)

- New functions such as 2 flaps control, 5-step airflow control, automatic airflow can be also adjusted with the new wired remote controller.



BRC1F61



Specifications

MODEL		FXEQ20AV36	FXEQ25AV36	FXEQ32AV36	FXEQ40AV36	FXEQ50AV36	FXEQ63AV36
Power supply		1-phase, 220-240 V, 50 Hz					
Cooling capacity	Btu/h	7,500	9,600	12,300	15,400	19,100	24,200
	kW	2.2	2.8	3.6	4.5	5.6	7.1
Capacity index		20	25	32	40	50	63
Power consumption	kW	0.026	0.027	0.034	0.046	0.048	0.067
Casing		Galvanised steel plate					
Airflow rate (H/HM/M/ML/L)	m ³ /min	6.0/5.4/4.9/4.4/4.0	6.9/6.4/5.8/5.3/4.8	8.0/7.5/7.0/6.3/5.5	9.8/8.8/7.8/7.0/6.2	12.5/11.4/10.4/9.5/8.7	15.0/13.6/12.2/11.0/9.8
	cfm	212/191/173/155/141	244/226/205/187/169	282/265/247/222/194	346/311/275/247/219	441/402/367/335/307	530/480/431/388/346
Sound level (H/HM/M/ML/L)	dB(A)	30/29/28/27/26	32/31/30/29/28	35/34/33/32/30	38/37/35/33/31	38/37/35/33/31	43/41/39/37/35
Dimensions (HxWxD)	mm	200x840x470				200x1,240x470	
Machine weight	kg	17			18	23	
Piping connections	Liquid (Flare)	φ 6.4					φ 9.5
	Gas (Flare)	φ 12.7					φ 15.9
	Drain	PVC26 (External Dia, 26/Internal Dia, 20)					
Panel (Option)	Model	BYEP40AW1				BYEP63AW1	
	Colour	Fresh white					
	Dimensions(HxWxD)	80x950x550				80x1,350x550	
	Weight	8.0				10.0	

Note: Specifications are based on the following conditions;

- Cooling: Indoor temp.: 27°CDB, 19°CWB, Outdoor temp.: 35°CDB, Equivalent piping length: 7.5 m, Level difference: 0 m.
- Capacity of indoor unit is only for reference. Actual capacity of indoor unit is based on the total capacity index. (See Engineering Data Book for details.)
- Sound level: Anechoic chamber conversion value, measured at a point 1 m in front of the unit and 1 m downward.

Indoor Unit Lineup

Slim Ceiling Mounted Duct Type (Standard Series) New FXDQ-PD / ND

Slim design, quietness and static pressure switching



Suitable to use in drop-ceilings!

- Only 700 mm in width and 23 kg in weight, this model is suitable to install in limited spaces like drop-ceilings in hotels.

Great for hotel use!



- Control of the airflow rate can be selected from 3-step control and Auto. Auto airflow rate control can be selected with wired remote controller BRC1E63.

- Low operation sound level.

- External static pressure selectable by remote controller switching make this indoor unit a very comfortable and flexible model.

10 Pa-30 Pa/factory set:
10 Pa for FXDQ-PD models.
15 Pa-44 Pa/factory set:
15 Pa for FXDQ-ND models.

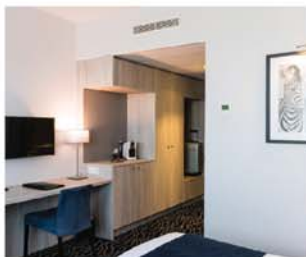

- Only 200 mm in height, this model can be installed in rooms with as little as 240 mm in height for the ceiling space between the drop-ceiling and ceiling slab.

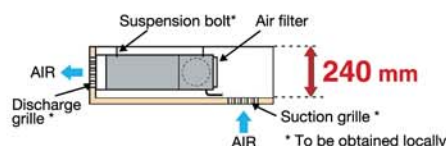

- FXDQ-PD and FXDQ-ND models are available in two types to suit different installation conditions.

FXDQ-PD/NDVE: with a drain pump (750 mm lift) as a standard accessory
FXDQ-PD/NDVET: without a drain pump

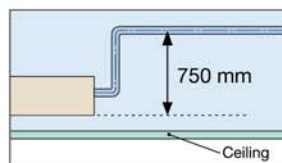

Specifications

MODEL	with drain pump	FXDQ20PDV	FXDQ25PDV	FXDQ32PDV	FXDQ40NDV	FXDQ50NDV	FXDQ63NDV
	without drain pump	FXDQ20PDVT	FXDQ25PDVT	FXDQ32PDVT	FXDQ40NDVT	FXDQ50NDVT	FXDQ63NDVT
Power supply	1-phase, 220-240 V/220 V, 50/60 Hz						
Cooling capacity	Btu/h	7,500	9,600	12,300	15,400	19,100	24,200
	kW	2.2	2.8	3.6	4.5	5.6	7.1
Power consumption (FXDQ-PDVE) *1	kW	0.086	0.086	0.089	0.160	0.165	0.181
Power consumption (FXDQ-PDVET) *1	kW	0.067	0.067	0.070	0.147	0.152	0.168
Casing	Galvanised steel plate						
Airflow rate (HH/H/L)	m ³ /min	8.0/7.2/6.4	8.0/7.2/6.4	8.0/7.2/6.4	10.5/9.5/8.5	12.5/11.0/10.0	16.5/14.5/13.0
	cfm	282/254/226	282/254/226	282/254/226	371/335/300	441/388/353	583/512/459
External static pressure	Pa	30-10*2			44-15*2		
Sound level (HH/H/L)*1*3	dB(A)	28/26/23		28/26/24	30/28/26	33/30/27	33/31/29
Dimensions (H×W×D)	mm	200×700×620	200×700×620	200×700×620	200×900×620	200×900×620	200×1,100×620
Machine weight	kg	23	23	23	27	28	31
Piping connections	Liquid (Flare)	φ6.4	φ6.4	φ6.4	φ6.4	φ6.4	φ9.5
	Gas (Flare)	φ12.7	φ12.7	φ12.7	φ12.7	φ12.7	φ15.9
	Drain	VP20 (External Dia, 26/Internal Dia, 20)					

Note: Specifications are based on the following conditions;

- Cooling: Indoor temp.: 27°CDB, 19°CWB, Outdoor temp.: 35°CDB, Equivalent piping length: 7.5 m, Level difference: 0 m.
 - Capacity of indoor unit is only for reference. Actual capacity of indoor unit is based on the total capacity index. (See Engineering Data Book for details.)
 - Sound level: Anechoic chamber conversion value, measured at a point 1.5 m downward from the unit centre.
- During actual operation, these values are normally somewhat higher as a result of ambient conditions.
- *1 : Values are based on the following conditions: FXDQ-PD: external static pressure of 10 Pa; FXDQ-ND: external static pressure of 15 Pa.
 - *2 : External static pressure is changeable to set by the remote controller. This pressure means "High static pressure - Standard". (Factory setting is 10 Pa for FXDQ-PD models and 15 Pa for FXDQ-ND models.)
 - *3 : The values of operation sound level represent those for rear-suction operation. Sound level values for bottom-suction operation can be obtained by adding 5 dB(A).

Slim Ceiling Mounted Duct Type (Compact Series) FXDQ-SP

Slim and compact design for easy and flexible installation



- It comes with a slim and compact design with a height of only 200 mm that requires as little as 240 mm in height for the ceiling space between the drop-ceiling and ceiling slab. The depth of the product is only 450 mm which is suitable to install in limited spaces.



- It is available in two types – ceiling return and ordinary duct to suit different installation conditions.

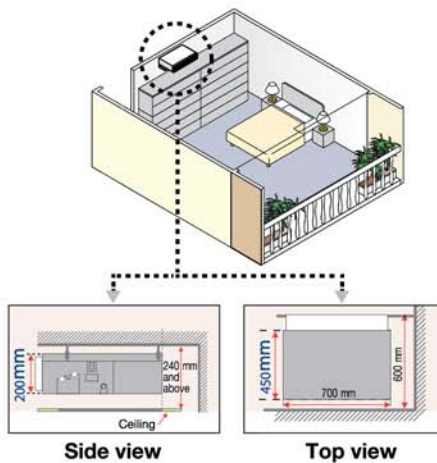
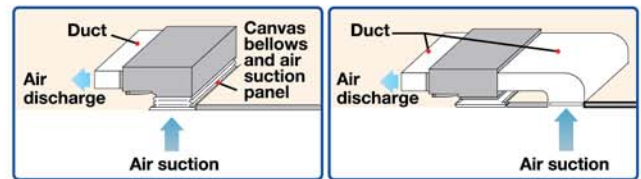

- Drain pump is equipped as standard accessory with 750 mm lift.

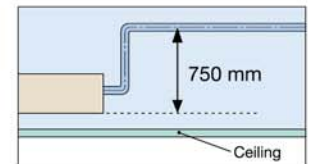

Specifications

MODEL		FXDQ20SPV1	FXDQ25SPV1	FXDQ32SPV1	FXDQ40SPV1	FXDQ50SPV1	FXDQ63SPV1
Power supply		1-phase, 220-240 V, 50 Hz					
Cooling capacity	Btu/h	7,500	9,600	12,300	15,400	19,100	24,200
	kW	2.2	2.8	3.6	4.5	5.6	7.1
Power consumption *1	kW	0.072	0.075	0.078	0.180	0.180	0.196
Casing		Galvanised steel plate					
Airflow rate (HH/H/L)	m ³ /min	8.7/7.6/6.5	9.0/8.0/7.0	10.0/9.0/8.0	15.0/13.0/10.5		20.0/16.0/12.5
	cfm	307/268/229	318/282/247	353/318/282	530/459/371		706/565/441
External static pressure	Pa	30-10*2			50-20*2		40-20*2
Sound level (HH/H/L) *1*3	dB(A)	33/31/29		34/32/30	35/33/31		37/35/33
Dimensions (H×W×D)	mm	200×700×450			200×900×450		200×1,100×450
Machine weight	kg	17					
Piping connections	Liquid (Flare)	φ6.4					
	Gas (Flare)	φ12.7					
	Drain	VP20 (External Dia, 26/Internal Dia, 20)					

Note: Specifications are based on the following conditions;

•Cooling: Indoor temp.: 27°CDB, 19°CWB, Outdoor temp.: 35°CDB, Equivalent piping length: 7.5 m, Level difference: 0 m.

•Capacity of indoor unit is only for reference. Actual capacity of indoor unit is based on the total capacity index. (See Engineering Data Book for details.)

•Sound level: Anechoic chamber conversion value, measured at a point 1.5 m downward from the unit centre.

During actual operation, these values are normally somewhat higher as a result of ambient conditions.

* 1 : Values are based on the following conditions: FXDQ20-32SP: external static pressure of 10 Pa; FXDQ40-63SP: external static pressure of 20 Pa.

* 2 : External static pressure is changeable to set by the remote controller. This pressure means "High static pressure - Standard". (Factorysetting is 10 Pa for FXDQ20-32SP models and 20 Pa for FXDQ40-63SP models.)

* 3 : The values of operation sound level represent those for rear-suction operation. Sound level values for bottom-suction operation can be obtained by adding 5 dB(A).

Indoor Unit Lineup

Middle Static Pressure Ceiling Mounted Duct Type

Middle external static pressure and slim design allow flexible installations



Installation flexibility

Slim design

- With a height of only 245 mm, installation is possible even in buildings with narrow ceiling spaces.

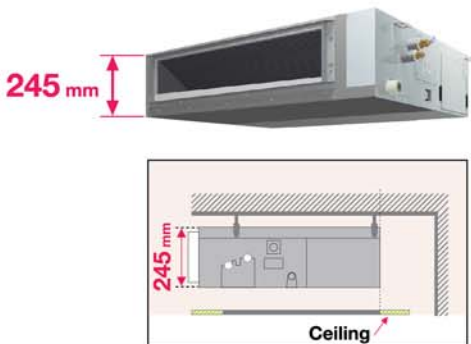

Standard DC drain pump

- DC drain pump is equipped as standard accessory with 850 mm lift.

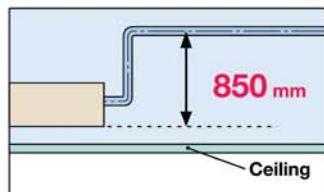

Bottom suction possible

- Bottom suction is possible which facilitate installation and maintenance. Wiring connections and maintenance of control box can be done from under the unit with an optional shield plate for side plate*, extending the degree of freedom for installation in the ceiling.

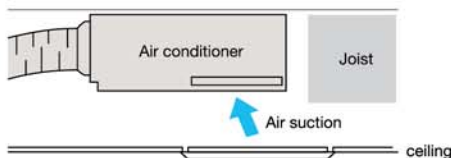

- Air suction direction can be altered from rear to bottom suction.

•Rear suction

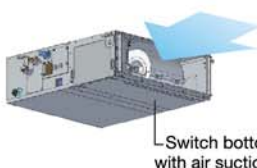

•Bottom suction

Shield plate for side plate* (Option)

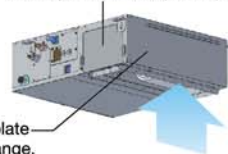

Switch bottom plate with air suction flange.

*An optional shield plate for side plate is required if wiring connections and maintenance of control box are needed from under the unit. This option is only available for FXSQ20-125PA models.

Design flexibility

Adjustable external static pressure

- Using a DC fan motor, the external static pressure can be controlled within a range of 30 Pa* to 150 Pa.



Set to low static pressure when ducts are short.

Set to high static pressure for advanced needs such as when using dampers and long ducts.

Comfortable airflow is achieved in accordance with conditions such as duct length.

- *30 Pa–150 Pa for FXSQ20-40PA2S
- 50 Pa–150 Pa for FXSQ50-125PA2S
- 50 Pa–140 Pa for FXSQ140PA2S

Comfort

Switchable airflow rate

- Control of the airflow rate can be selected from 3-step control.

Auto airflow rate

- 5-step airflow rate is automatically controlled in accordance with the difference between room temperature and set temperature. Auto airflow rate control can be selected with wired remote controller BRC1E63.

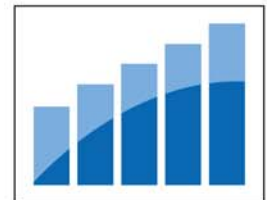

Low operation sound level

(dB(A))

FXSQ-PA2S	20/25	32	40	50	63
Sound level (H/M/L)	33/30/28	34/32/30	36/33/30	34/32/29	36/32/29

FXSQ-PA2S	80	100	125	140
Sound level (H/M/L)	37.5/34/30	39/35/32	42/38.5/35	43/40/36



Easy installation

Airflow rate auto adjustment function

- During installation, even if the external static pressure changes due to a change in the duct route, the airflow can be automatically adjusted to within the unit's external static pressure range.
- Airflow rate can be controlled using a remote controller during test operation. It is automatically adjusted to the range between approximately $\pm 10\%$ of the rated H tap airflow.

Specifications

MODEL		FXSQ20PA2S	FXSQ25PA2S	FXSQ32PA2S	FXSQ40PA2S	FXSQ50PA2S
Power supply		1-phase, 220-240 V/220 V, 50/60 Hz				
Cooling capacity	Btu/h	7,500	9,600	12,300	15,400	19,100
	kW	2.2	2.8	3.6	4.5	5.6
Power consumption	kW	0.058 *1	0.058 *1	0.066 *1	0.101 *1	0.075 *1
Casing		Galvanised steel plate				
Airflow rate (H/M/L)	m ³ /min	9/7.5/6.5	9/7.5/6.5	9.5/8/7	15/12.5/10.5	17/14.5/11.5
	cfm	318/265/230	318/265/230	335/282/247	530/441/371	600/512/406
External static pressure	Pa	30-150 (50) *2				50-150 (50) *2
Sound level (H/M/L)	dB(A)	33/30/28		34/32/30	36/33/30	34/32/29
Dimensions (HxWxD)	mm	245x550x800			245x700x800	245x1,000x800
Machine weight	kg	25		27	35	
Piping connections	Liquid (Flare)	ϕ 6.4				
	Gas (Flare)	ϕ 12.7				
	Drain	VP25 (External Dia, 32/Internal Dia, 25)				

MODEL		FXSQ63PA2S	FXSQ80PA2S	FXSQ100PA2S	FXSQ125PA2S	FXSQ140PA2S
Power supply		1-phase, 220-240 V/220 V, 50/60 Hz				
Cooling capacity	Btu/h	24,200	30,700	38,200	47,800	54,600
	kW	7.1	9.0	11.2	14.0	16.0
Power consumption	kW	0.106 *1	0.126 *1	0.151 *1	0.206 *1	0.222 *1
Casing		Galvanised steel plate				
Airflow rate (H/M/L)	m ³ /min	21/17.5/14.5	23/19.5/16	32/27/22.5	37/31.5/26	39/33.5/28
	cfm	741/618/512	812/688/565	1,130/953/794	1,306/1,112/918	1,377/1,183/988
External static pressure	Pa	50-150 (50) *2				50-140 (50) *2
Sound level (H/M/L)	dB(A)	36/32/29	37.5/34/30	39/35/32	42/38.5/35	43/40/36
Dimensions (HxWxD)	mm	245x1,000x800		245x1,400x800		245x1,550x800
Machine weight	kg	35	37	46	47	52
Piping connections	Liquid (Flare)	ϕ 9.5				
	Gas (Flare)	ϕ 15.9				
	Drain	VP25 (External Dia, 32/Internal Dia, 25)				

Easy maintenance

- Inspection and cleaning is facilitated by separating the drain pipe and inspection opening and by the drain pan maintenance check hole.

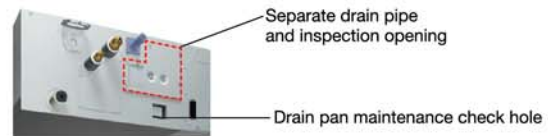

- An antibacterial treatment that uses silver ions has been applied to the drain pan, preventing the growth of slime, mould and bacteria that cause blockages and odours. (The lifespan of a silver ion cartridge depends on the usage environment, but should be changed once every two to three years.)



Note: Specifications are based on the following conditions;

•Cooling: Indoor temp.: 27°CDB, 19°CWB, Outdoor temp.: 35°CDB, Equivalent piping length: 7.5 m, Level difference: 0 m.

•Capacity of indoor unit is only for reference. Actual capacity of indoor unit is based on the total capacity index. (See Engineering Data Book for details.)

•Sound level: Anechoic chamber conversion value, measured at a point 1.5 m downward from the unit centre.

During actual operation, these values are normally somewhat higher as a result of ambient conditions.

*1: Power consumption values are based on conditions of rated external static pressure.

*2: External static pressure can be modified using a remote controller that offers thirteen (FXSQ20-40PA), eleven (FXSQ50-125PA) or ten (FXSQ140PA) levels of control. These values indicate the lowest and highest possible static pressures. The rated static pressure is 50 Pa.

Indoor Unit Lineup

Ceiling Mounted Duct Type

Middle and high static pressure allows for flexible duct design



- Using a DC fan motor, the external static pressure can be controlled within a range of 30 Pa* to 200 Pa*.



Set to low static pressure when ducts are short.

Set to high static pressure for advanced needs such as when using dampers and long ducts.

Comfortable airflow is achieved in accordance with conditions such as duct length.

- *30 Pa–100 Pa for FXMQ20P-32PA
- *30 Pa–160 Pa for FXMQ40PA
- *50 Pa–200 Pa for FXMQ50PA-125PA
- *50 Pa–140 Pa for FXMQ140PA

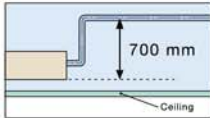
- All models are only 300 mm in height and the weight of the FXMQ40-140PA has been reduced.
- Drain pump is equipped as standard accessory with 700 mm lift.
 
- Control of the airflow rate can be selected from 3-step control and Auto. Auto airflow rate control can be selected with wired remote controller BRC1E63.
- Low operation sound level
- Energy-efficient
 - DC fan motor is used to realise energy-saving operation.
- Easy installation
 - Airflow rate can be controlled using a remote controller during test operation. It is automatically adjusted to the range between approximately $\pm 10\%$ of the rated HH tap airflow for FXMQ20P-125PA.



- Easy maintenance

- Inspection and cleaning is facilitated by separating the drain pipe and inspection opening and by the drain pan maintenance check hole.

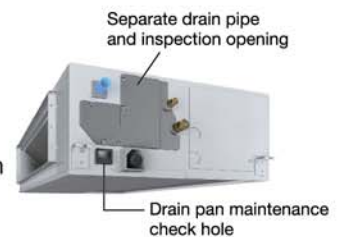

- An antibacterial treatment that uses silver ions has been applied to the drain pan, preventing the growth of slime, mould and bacteria that cause blockages and odours. (The lifespan of a silver ion cartridge depends on the usage environment, but should be changed once every two to three years.)



FXMQ200/250MA

- Simplified Static Pressure Control
External static pressure can be easily adjusted using a change-over switch inside the electrical box to meet the resistance in the duct system.

- Built-in Drain Pump (Option)

Housing the drain pump inside the unit reduces the space required for installation.

- Without drain pump

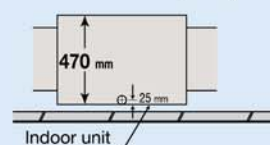

- With drain pump

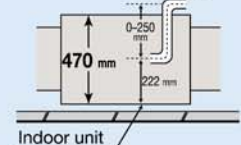

Specifications

MODEL		FXMQ20PAVS	FXMQ25PAVS	FXMQ32PAVS	FXMQ40PAVS	FXMQ50PAVS
Power supply		1-phase, 220-240 V/220 V, 50/60 Hz				
Cooling capacity	Btu/h	7,500	9,600	12,300	15,400	19,100
	kW	2.2	2.8	3.6	4.5	5.6
Power consumption	kW	0.056 *1	0.056 *1	0.060 *1	0.151 *1	0.128 *1
Casing		Galvanised steel plate				
Airflow rate (HH/H/L)	m ³ /min	9/7.5/6.5	9/7.5/6.5	9.5/8/7	16/13/11	18/16.5/15
	cfm	318/265/230	318/265/230	335/282/247	565/459/388	635/582/530
External static pressure	Pa	30-100 (50) *2	30-100 (50) *2	30-100 (50) *2	30-160 (100) *2	50-200 (100) *2
Sound level (HH/H/L)	dB(A)	33/31/29	33/31/29	34/32/30	39/37/35	41/39/37
Dimensions (H×W×D)	mm	300×550×700	300×550×700	300×550×700	300×700×700	300×1,000×700
Machine weight	kg	25	25	25	27	35
Piping connections	Liquid (Flare)	φ 6.4	φ 6.4	φ 6.4	φ 6.4	φ 6.4
	Gas (Flare)	φ 12.7	φ 12.7	φ 12.7	φ 12.7	φ 12.7
	Drain	VP25 (External Dia, 32/Internal Dia, 25)				

MODEL		FXMQ63PAVS	FXMQ80PAVS	FXMQ100PAVS	FXMQ125PAVS	FXMQ140PAVS
Power supply		1-phase, 220-240 V/220 V, 50/60 Hz				
Cooling capacity	Btu/h	24,200	30,700	38,200	47,800	54,600
	kW	7.1	9.0	11.2	14.0	16.0
Power consumption	kW	0.138 *1	0.185 *1	0.215 *1	0.284 *1	0.405 *1
Casing		Galvanised steel plate				
Airflow rate (HH/H/L)	m ³ /min	19.5/17.5/16	25/22.5/20	32/27/23	39/33/28	46/39/32
	cfm	688/618/565	883/794/706	1,130/953/812	1,377/1,165/988	1,624/1,377/1,130
External static pressure	Pa	50-200 (100) *2	50-200 (100) *2	50-200 (100) *2	50-200 (100) *2	50-140 (100) *2
Sound level (HH/H/L)	dB(A)	42/40/38	43/41/39	43/41/39	44/42/40	46/45/43
Dimensions (H×W×D)	mm	300×1,000×700	300×1,000×700	300×1,400×700	300×1,400×700	300×1,400×700
Machine weight	kg	35	35	45	45	46
Piping connections	Liquid (Flare)	φ 9.5	φ 9.5	φ 9.5	φ 9.5	φ 9.5
	Gas (Flare)	φ 15.9	φ 15.9	φ 15.9	φ 15.9	φ 15.9
	Drain	VP25 (External Dia, 32/Internal Dia, 25)				

Note: Specifications are based on the following conditions;

- Cooling: Indoor temp.: 27°CDB, 19°CWB, Outdoor temp.: 35°CDB, Equivalent piping length: 7.5 m, Level difference: 0 m.
- Capacity of indoor unit is only for reference. Actual capacity of indoor unit is based on the total capacity index. (See Engineering Data Book for details.)
- Sound level: Anechoic chamber conversion value, measured at a point 1.5 m downward from the unit centre.

During actual operation, these values are normally somewhat higher as a result of ambient conditions.

*1: Power consumption values are based on conditions of rated external static pressure.

*2: External static pressure can be modified using a remote controller that offers seven (FXMQ20-32PA), thirteen (FXMQ40PA), fourteen (FXMQ50-125PA) or ten (FXMQ140PA) levels of control. These values indicate the lowest and highest possible static pressures. The standard static pressure is 50 Pa for FXMQ20-32PA and 100 Pa for FXMQ40-140PA.

MODEL		FXMQ200MAVE	FXMQ250MAVE
Power supply		1-phase, 220-240 V/220 V, 50/60 Hz	
Cooling capacity	Btu/h	76,400	95,500
	kW	22.4	28.0
Power consumption	kW	1.294 *1	1.465 *1
Casing		Galvanised steel plate	
Airflow rate (H/L)	m ³ /min	58/50	72/62
	cfm	2,047/1,765	2,542/2,189
External static pressure	Pa	132-221 *2	191-270 *2
Sound level (H/L)	220 V	48/45	48/45
	240 V	49/46	49/46
Dimensions (H×W×D)	mm	470×1,380×1,100	470×1,380×1,100
Machine weight	kg	137	137
Piping connections	Liquid (Flare)	φ 9.5	φ 9.5
	Gas (Braze)	φ 19.1	φ 22.2
	Drain	PS1B	

Note: Specifications are based on the following conditions;

- Cooling: Indoor temp.: 27°CDB, 19°CWB, Outdoor temp.: 35°CDB, Equivalent piping length: 7.5 m, Level difference: 0 m.
- Capacity of indoor unit is only for reference. Actual capacity of indoor unit is based on the total capacity index. (See Engineering Data Book for details.)
- Sound level: (FXMQ-MA) Anechoic chamber conversion value, measured at a point 1.5 m downward from the unit centre.

During actual operation, these values are normally somewhat higher as a result of ambient conditions.

*1: Power consumption values are based on conditions of standard external static pressure.

*2: External static pressure is changeable to change over the connectors inside electrical box, this pressure means "Standard-High static pressure".

Indoor Unit Lineup

4-way Flow Ceiling Suspended Type

FXUQ-A

This slim and stylish indoor unit achieves optimum air distribution, and can be installed without the need for ceiling cavity.

- Unit body and suction panel adopted round shapes and realised a slim appearance design. The unit can be used for various locations such as the ceilings with no cavity and bare ceilings.
- Flaps close automatically when the unit stops, which gives a simple appearance.
- Unified slim height of 198 mm for all model that gives the unified impression even when models with different capacities are installed in the same area.
- With adoption of the individual flap control, airflow direction adjustment can be individually set for each air outlet. 5 directions of airflow and auto-swing can be selected with wired remote controller BRC1E63, which realises the optimum air distribution.

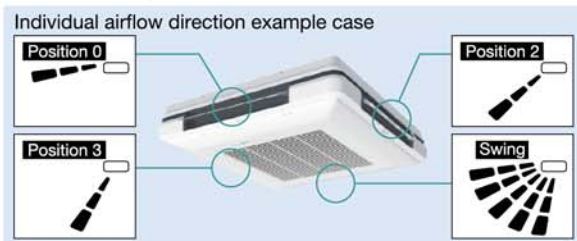

- Built-in electronic expansion valve eliminates the need for a BEV unit, which improves flexibility of installation.

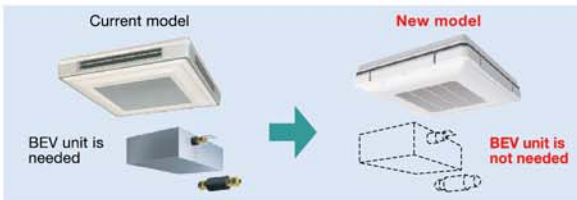

- Control of the airflow rate has been improved from 2-step to 3-step control. Auto airflow rate control can be selected with wired remote controller BRC1E63.
- Energy efficiency has been improved thanks to the adoption of a new heat exchanger with smaller tubes, DC fan motor and DC drain pump motor.
- Drain pump is equipped as a standard accessory, and the lift height has been improved from 500 mm to 600 mm.
- Depending on installation site requirements or room conditions, 2-way, 3-way and 4-way discharge patterns are available.



- An antibacterial treatment that uses silver ions has been applied to the drain pan, preventing the growth of slime, mould and bacteria that cause blockages and odours. (The lifespan of a silver ion cartridge depends on the usage environment, but should be changed once every two to three years.)



Specifications

MODEL		FXUQ71AVEB	FXUQ100AVEB
Power supply		1-phase, 220-240 V/220-230 V, 50/60 Hz	
Cooling capacity	Btu/h	27,300	38,200
	kW	8.0	11.2
Power consumption	kW	0.090	0.200
Casing		Fresh white	
Airflow rate (H/M/L)	m ³ /min	22.5/19.5/16	31/26/21
	cfm	794/688/565	1,094/918/741
Sound level (H/M/L)	dB(A)	40/38/36	47/44/40
Dimensions (H×W×D)	mm	198×950×950	
Machine weight	kg	26	27
Piping connections	Liquid (Flare)	φ9.5	
	Gas (Flare)	φ15.9	
	Drain	VP20 (External Dia, 26/Internal Dia, 20)	

Note: Specifications are based on the following conditions;

- Cooling: Indoor temp.: 27°CDB, 19°CWB, Outdoor temp.: 35°CDB, Equivalent piping length: 7.5 m, Level difference: 0 m.
- Capacity of indoor unit is only for reference. Actual capacity of indoor unit is based on the total capacity index. (See Engineering Data Book for details.)
- Sound level:(FXUQ-A) Anechoic chamber conversion value, measured at a point 1 m in front of the unit and 1 m downward.

During actual operation, these values are normally somewhat higher as a result of ambient conditions

※1: Power consumption values are based on conditions of standard external static pressure.

※2: External static pressure is changeable to change over the connectors inside electrical box, this pressure means "Standard-High static pressure".

Ceiling Suspended Type

FXHQ-MA

Slim body with quiet and wide airflow



●Adoption of QUIET STREAM FAN

Uses the quiet stream fan and many more advanced technologies.

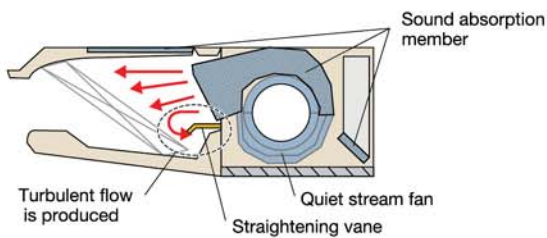

●Wide air discharge openings produce a spreading of 100° airflow.

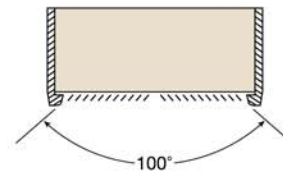

●Low operation sound level

●Installation is easy

- Drain pump kit (option) can be easily incorporated.

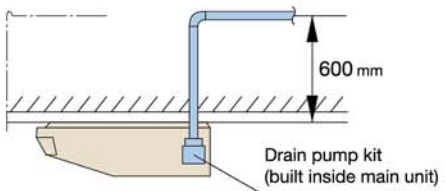

●Maintenance is easy

- Non-dew Flap with no implanted bristles
- Bristle-free Flap minimises contamination and makes cleaning simpler.



●Easy-to-clean flat design

- Maintenance is easier because everything can be performed from below the unit.

- A long-life filter (maintenance free up to one year*) is equipped as standard accessory.

* 8 hr/day, 25 day/month. For dust concentration of 0.15 mg/m³

Specifications

MODEL		FXHQ32MAVS	FXHQ63MAVS	FXHQ100MAVS
Power supply		1-phase, 220-240 V/220 V, 50/60 Hz		
Cooling capacity	Btu/h	12,300	24,200	38,200
	kW	3.6	7.1	11.2
Power consumption	kW	0.111	0.115	0.135
Casing		White (10Y9/0.5)		
Airflow rate (H/L)	m ³ /min	12/10	17.5/14	25/19.5
	cfm	424/353	618/494	883/688
Sound level (H/L)	dB(A)	36/31	39/34	45/37
Dimensions (H×W×D)	mm	195×960×680	195×1,160×680	195×1,400×680
Machine weight	kg	24.0	28.0	33.0
Piping connections	Liquid (Flare)	φ6.4	φ9.5	φ9.5
	Gas (Flare)	φ12.7	φ15.9	φ15.9
	Drain	VP20 (External Dia, 26/Internal Dia, 20)		

Note: Specifications are based on the following conditions;

- Cooling: Indoor temp.: 27°CDB, 19°CWB, Outdoor temp.: 35°CDB, Equivalent piping length: 7.5 m, Level difference: 0 m.
- Capacity of indoor unit is only for reference. Actual capacity of indoor unit is based on the total capacity index. (See Engineering Data Book for details.)
- Sound level: Anechoic chamber conversion value, measured at a point 1 m in front of the unit and 1 m downward. During actual operation, these values are normally somewhat higher as a result of ambient conditions.

Indoor Unit Lineup

Wall Mounted Type

FXAQ-P

Stylish flat panel design harmonised with your interior decoration



- Stylish flat panel design creates a graceful harmony that enhances any interior space.
- Flat panel can be cleaned with only the single pass of a cloth across their smooth surface. Flat panel can also be easily removed and washed for more thorough cleaning.
- Low operation sound level
- Drain pan and air filter can be kept clean by mould-proof polystyrene.
- Vertical auto-swing realises efficiency of air distribution. The louvre closes automatically when the unit stops.
- 5 steps of discharge angle can be set by remote controller.

- Discharge angle is automatically set at the same angle as the previous operation when restarting. (Initial setting: 10° for cooling)
- Flexible installation
 - Drain pipe can be fitted to from either left or right sides.
- Drain pump kit is available as optional accessory, which lifts the drain 1,000 mm from the bottom of the unit.

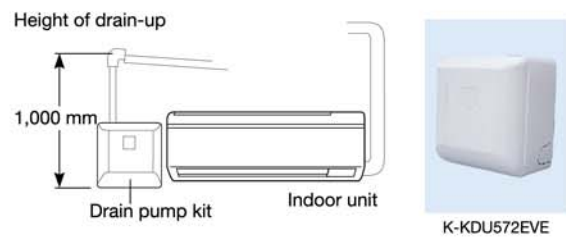

Specifications

MODEL		FXAQ20PVES	FXAQ25PVES	FXAQ32PVES	FXAQ40PVES	FXAQ50PVES	FXAQ63PVES
Power supply		1-phase, 220-240 V/220 V, 50/60 Hz					
Cooling capacity	Btu/h	7,500	9,600	12,300	15,400	19,100	24,200
	kW	2.2	2.8	3.6	4.5	5.6	7.1
Power consumption	kW	0.019	0.028	0.030	0.020	0.033	0.050
Casing		White (3.0Y8.5/0.5)					
Airflow rate (H/L)	m ³ /min	7.5/4.5	8/5	8.5/5.5	12/9	15/12	19/14
	cfm	265/159	282/177	300/194	424/318	530/424	671/494
Sound level (H/L)	dB(A)	35/31	36/31	38/31	39/34	42/37	47/41
Dimensions (H×W×D)	mm	290×795×238	290×795×238	290×795×238	290×1,050×238	290×1,050×238	290×1,050×238
Machine weight	kg	11.0	11.0	11.0	14.0	14.0	14.0
Piping connections	Liquid (Flare)	φ 6.4	φ 6.4	φ 6.4	φ 6.4	φ 6.4	φ 9.5
	Gas (Flare)	φ 12.7	φ 12.7	φ 12.7	φ 12.7	φ 12.7	φ 15.9
	Drain	VP13 (External Dia, 18/Internal Dia, 13)					

Note: Specifications are based on the following conditions;

- Cooling: Indoor temp.: 27°CDB, 19°CWB, Outdoor temp.: 35°CDB, Equivalent piping length: 7.5 m, Level difference: 0 m.
- Capacity of indoor unit is only for reference. Actual capacity of indoor unit is based on the total capacity index. (See Engineering Data Book for details.)
- Sound level: Anechoic chamber conversion value, measured at a point 1 m in front of the unit and 1 m downward. During actual operation, these values are normally somewhat higher as a result of ambient conditions.

Floor Standing Type

FXLQ-MA

Suitable for perimeter zone air conditioning



- Floor Standing types can be hung on the wall for easier cleaning. Running the piping from the back allows the unit to be hung on walls. Cleaning under the unit, where dust tends to accumulate, is considerably easier.
- The adoption of a fibre-less discharge grille featuring an original design to prevent condensation also helps prevent staining and makes cleaning easier.
- A long-life filter (maintenance free up to one year*) is equipped as standard accessory.

* 8 hr/day, 25 day/month. For dust concentration of 0.15 mg/m³

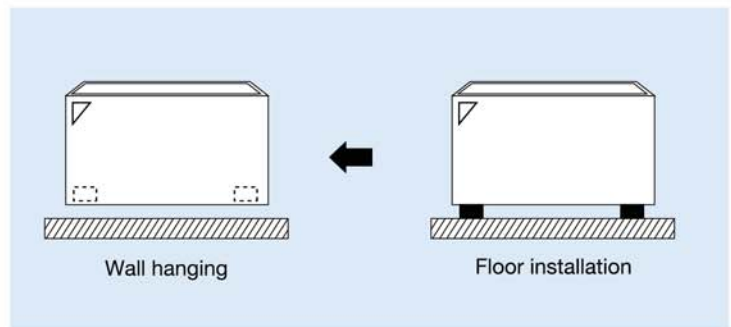

Specifications

MODEL		FXLQ20MAVE8	FXLQ25MAVE8	FXLQ32MAVE8	FXLQ40MAVE8	FXLQ50MAVE8	FXLQ63MAVE8	
Power supply		1-phase, 220-240 V/220 V, 50/60 Hz						
Cooling capacity	Btu/h	7,500	9,600	12,300	15,8400	19,100	24,200	
	kW	2.2	2.8	3.6	4.5	5.6	7.1	
Power consumption	kW	0.049	0.049	0.090	0.090	0.110	0.110	
Casing		Ivory white (5Y7.5/1)						
Airflow rate (H/L)	m ³ /min	7/6	7/6	8/6	11/8.5	14/11	16/12	
	cfm	247/212	247/212	282/212	388/300	494/388	565/424	
Sound level (H/L)	220 V	dB(A)	35/32	35/32	35/32	38/33	39/34	40/35
	240 V		37/34	37/34	37/34	40/35	41/36	42/37
Dimensions (H×W×D)		mm	600×1,000×222	600×1,000×222	600×1,140×222	600×1,140×222	600×1,420×222	600×1,420×222
Machine weight		kg	25.0	25.0	30.0	30.0	36.0	36.0
Piping connections	Liquid (Flare)	mm	φ6.4	φ6.4	φ6.4	φ6.4	φ6.4	φ9.5
	Gas (Flare)		φ12.7	φ12.7	φ12.7	φ12.7	φ12.7	φ15.9
	Drain		210.D.					

Note: Specifications are based on the following conditions;
 • Cooling: Indoor temp.: 27°CDB, 19°CWB, Outdoor temp.: 35°CDB, Equivalent piping length: 7.5 m, Level difference: 0 m.
 • Capacity of indoor unit is only for reference. Actual capacity of indoor unit is based on the total capacity index. (See Engineering Data Book for details.)
 • Sound level: Anechoic chamber conversion value, measured at a point 1.5 m in front of the unit at a height of 1.5 m. During actual operation, these values are normally somewhat higher as a result of ambient conditions.

Indoor Unit Lineup

Concealed Floor Standing Type

FXNQ-MA

Designed to be concealed in the perimeter skirting-wall



• The unit is concealed in skirting-wall of perimeter, that enables to create high class interior design.

• The connecting port faces downward, greatly facilitating on-site piping work.

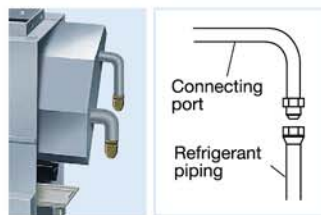

* Applies also to Floor Standing type (FXLQ-MA).

• A long-life filter (maintenance free up to one year*) is equipped as standard accessory.

* 8 hr/day, 25 day/month. For dust concentration of 0.15 mg/m³

Specifications

MODEL		FXNQ20MAVE8	FXNQ25MAVE8	FXNQ32MAVE8	FXNQ40MAVE8	FXNQ50MAVE8	FXNQ63MAVE8
Power supply		1-phase, 220-240 V/220 V, 50/60 Hz					
Cooling capacity	Btu/h	7,500	9,600	12,300	15,400	19,100	24,200
	kW	2.2	2.8	3.6	4.5	5.6	7.1
Power consumption	kW	0.049	0.049	0.090	0.090	0.110	0.110
Casing		Galvanised steel plate					
Airflow rate (H/L)	m ³ /min	7/6	7/6	8/6	11/8.5	14/11	16/12
	cfm	247/212	247/212	282/212	388/300	494/388	565/424
Sound level (H/L)	220 V	35/32	35/32	35/32	38/33	39/34	40/35
	240 V	37/34	37/34	37/34	40/35	41/36	42/37
Dimensions (H×W×D)	mm	610×930×220	610×930×220	610×1,070×220	610×1,070×220	610×1,350×220	610×1,350×220
Machine weight	kg	19.0	19.0	23.0	23.0	27.0	27.0
Piping connections	Liquid (Flare)	φ6.4	φ6.4	φ6.4	φ6.4	φ6.4	φ9.5
	Gas (Flare)	φ12.7	φ12.7	φ12.7	φ12.7	φ12.7	φ15.9
	Drain	21O.D.					

Note: Specifications are based on the following conditions:

• Cooling: Indoor temp.: 27°CDB, 19°CWB, Outdoor temp.: 35°CDB, Equivalent piping length: 7.5 m, Level difference: 0 m.

• Capacity of indoor unit is only for reference. Actual capacity of indoor unit is based on the total capacity index.

(See Engineering Data Book for details.)

• Sound level: Anechoic chamber conversion value, measured at a point 1.5 m in front of the unit at a height of 1.5 m.

During actual operation, these values are normally somewhat higher as a result of ambient conditions.

Floor Standing Duct Type

FXVQ-N

**Large airflow type for large spaces.
Flexible interior design for each tenant.**

- Large airflow type that fits for spacious areas such as factories and large stores.
- Various installations can be supported from full-scale duct connection airflow to direct airflow that allows easy installation.

- Full-scale duct connection airflow allows for air conditioning evenly in spacious areas.

Duct connection airflow type

- Adding the plenum chamber (option) allows for simple operation with direct airflow.
* Note that the operation sound increases by approximately 5dB(A).

Direct airflow type

- The high static pressure type driven by the belt drive system allows for use of air discharge outlets in various shapes as well as long ducts. Highly flexible installation is possible.
- Design with high maintainability that allows major services and maintenance services to be performed at the front.
- A long-life filter (maintenance free up to one year*) is equipped as a standard accessory. * 8 hr/day, 26 day/month. For dust concentration of 0.15 mg/m³
- A wide range of optional accessories are available such as high-efficiency filters.

- Outdoor air intake mode is useable as an outdoor-air processing air conditioner.

*When using the unit as an outdoor-air processing unit, there are some restrictions. Strictly follow the restrictions specified in the Engineering Data Book.

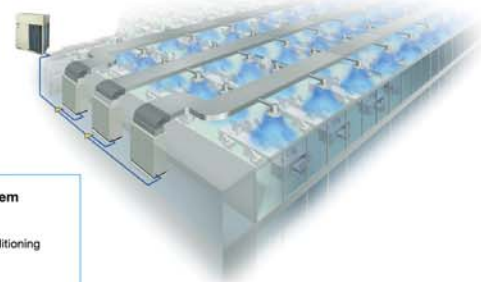
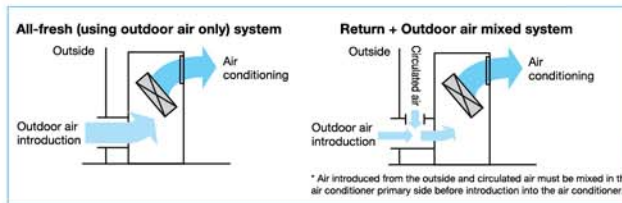

Specifications

MODEL		FXVQ125NY1	FXVQ200NY1	FXVQ250NY1	FXVQ400NY1	FXVQ500NY1	FXVQ500NY16	
Power supply		3-phase 4-wire system, 380-415 V, 50 Hz						
Cooling capacity	Btu/h	47,800	76,400	95,500	154,000	191,000		
	kW	14.0	22.4	28.0	45.0	56.0		
Power consumption	kW	0.53	1.33	1.61	3.97	2.62	4.70	
Casing colour		Ivory white (5Y7.5/1)						
Dimensions (HxWxD)	mm	1,670x750x510	1,670x950x510	1,670x1,170x510	1,900x1,170x720	1,900x1,470x720		
Machine weight	kg	118	144	169	236	281	306	
Sound level *1	dB(A)	52	56	60	65	62	66	
Piping connections	Liquid	φ 9.5 (Brazing)			φ 12.7 (Brazing)		φ 15.9 (Brazing)	
	Gas	φ 15.9 (Brazing)	φ 19.1 (Brazing)	φ 22.2 (Brazing)	φ 28.6 (Brazing)			
	Drain	Rp1 (PS 1B internal thread)						
Air filter	Type	Long-life filter (anti-mould resin net)						
Fan	Motor output	0.75		1.5		3.7		
	Airflow rate	m ³ /min	43	69	86	134	165	172
		cfm	1,518	2,436	3,036	4,730	5,825	6,072
	External static pressure *2	Pa	152	217	281	420	142	390
Drive system		Belt drive system						

Note: Specifications are based on the following conditions:
 • Cooling: Indoor temp.: 27°CDB, 19°CWB, Outdoor temp.: 35°CDB, Equivalent piping length: 7.5 m, Level difference: 0 m.
 • Capacity of indoor unit is only for reference. Actual capacity of indoor unit is based on the total capacity index. (See Engineering Data Book for details.)
 *1: Sound level : measured when the air discharge outlet duct (2 m) is attached (anechoic chamber conversion value). It increases by approximately 5 dB(A) when the plenum chamber is installed to deliver direct airflow.
 *2: The value is the external static pressure with standard pulley.

Indoor Unit Lineup

Clean Room Air Conditioner

Suitable for hospitals and other clean spaces



Easily provides the high cleanliness environment required by various industries

Daikin's clean room air conditioners are specially designed to achieve an environment cleanliness class 10,000. These air conditioners easily realize a cleanliness-class environment and help create a proper environment of hospitals, food and beverage factories, electronics factories, and other spaces that require clean air.

Select the air flow system and installation method to match the layout and purpose of the room

Two types of clean room air conditioners are available – an integrated unit model and a separate outlet unit model. It is also possible to configure the air flow system to ceiling intake or floor-level intake according to the panel selected. This flexible design enables the air conditioner to easily adopt to any room layout or use.

Instances of installation by type (for a hospital)

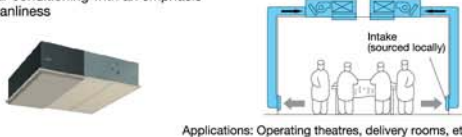
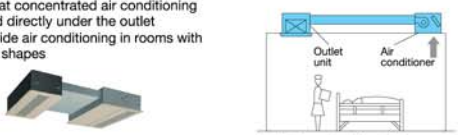
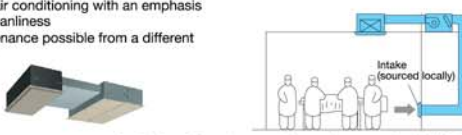
Type	Ceiling intake type (high speed contracted flow/high ceiling model)	Floor-level intake type (gentle wind distribution/high cleanliness class model)
Features	Construction work is simple and a ceiling installation is possible. Dust filtering and air-conditioning can be started immediately.	Easy to increase the cleanliness and air-conditioning effect. A low flow speed prevents drying of the affected part and the experience of drafts.
Cleanliness class ^{*1}	100,000 to 10,000	10,000
Wind speed	1.0m/s or higher	Approximately 0.5m/s
Blow method	Integrated outlet unit model ☒ Concentrated air conditioning centered directly under the unit ☒ Easy installation  Applications: Surgery prep rooms, recovery rooms, nurse stations, etc.	Floor-level intake type ☒ Total air conditioning with an emphasis on cleanliness  Applications: Operating theatres, delivery rooms, etc.
	Separate outlet unit model ☒ Somewhat concentrated air conditioning centered directly under the outlet ☒ Can provide air conditioning in rooms with irregular shapes  Applications: CCU ^{*2} , sterile rooms, etc.	Floor-level intake type ☒ Total air conditioning with an emphasis on cleanliness ☒ Maintenance possible from a different room  Applications: Premature nurseries, newborn nurseries, ICU ^{*3} , etc.

^{*1}. Cleanliness class. A scale expressing the cleanliness of air established by NASA (National Aeronautics and Space Administration). Class 10,000 represents a state of less than 10,000 minute particles of diameter under 0.5 μm per cubic foot. For comparison, the cleanliness of a typical office is around class 1,000,000.
^{*2}. CCU (Cardiac Care Unit). A ward dedicated to the admission of patients with myocardial infarctions and other heart diseases.
^{*3}. ICU (Intensive Care Unit). A ward for the careful treatment and nursing of patients with serious illnesses, injuries, or recovering from operations.

Can be easily installed in existing buildings

A simple structure makes it easy to realize a highly clean environment with the same installation work as for a typical air conditioner. Can be easily installed in new buildings, existing structures, and refurbishments.

Prevents uncomfortable drafts with a low flow speed of approximately 0.5m/s

The floor-level intake system has a low flow speed of approximately 0.5 m/s, improving dust filtration and eliminating the feeling of drafts. Broadly air-conditions the room with a gentle air flow and creates a comfortable environment.

• Air flow distribution diagram (operating theatre)

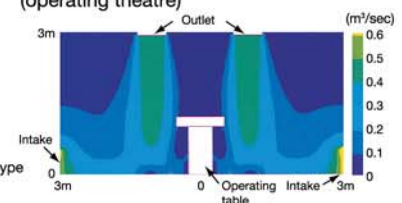

*Analysis of the floor-level intake type with the integrated outlet model.

Filtration

Class 10,000 clean room condition achieved with a HEPA filter (sold separately)

The low pressure-loss HEPA filter (sold separately) demonstrates superior dust filtering performance and easily accomplishes an air cleanliness of class 10,000.

The HEPA filter has a structure incorporating a pleated glass fiber filter medium, making it highly efficient and suitable for clean rooms, etc.



*It may not be possible to maintain cleanliness in rooms with low air tightness.



Installation example (in a medical facility)

Antibacterial

Suppresses the propagation of bacteria in the duct with a proprietary antibacterial coating

The filter implements an antibacterial treatment with a new coating combining a silver-based inorganic antibacterial material (an organic antibacterial material that is effective against germs) that prevents mould. This enhances the antibacterial properties of the duct.

An antibacterial treatment using a silver-based organic substance reduces mould.

Antibacterial fiber used in the intake filter

With a long-life filter employing anti-mould antibacterial fiber near the intake, cleaning performance is further enhanced.

*Please be aware that antibacterial products suppress the propagation of bacteria but do not have a sterilizing effect. Also, mould may grow in places where dust or soot accumulates.

*A material for which the registered safety was verified by Japanese chemicals and dangerous substances regulation law (Act on the Evaluation of Chemical Substances and Regulation of Their Manufacture, etc) is used for the antibacterial material.

*Periodic maintenance is required (such as cleaning the air filter and washing the inside of the unit).

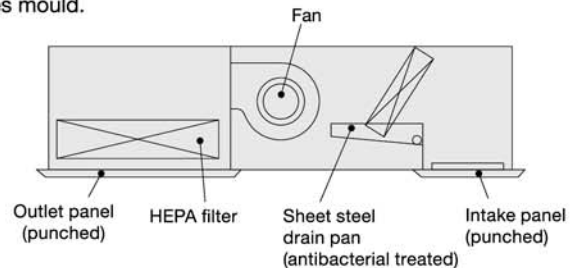

Labor-saving

Filter maintenance unnecessary for about five years

Easy access from underneath unit provides easy maintenance

The HEPA filter has an exceptionally long life and does not require maintenance for about five years. Daikin has aimed to reduce maintenance work from a variety of perspectives, including a service access system that eliminates the necessity for service panels.

*The maintenance period differs significantly according to the cleanliness of the room and hours of air conditioner operation.

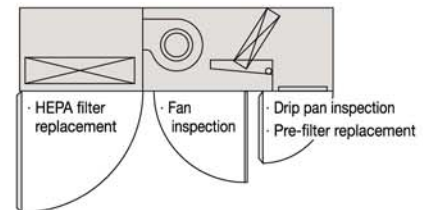

Quiet

All models incorporate an industry-leading quiet design, operating at under 41dB

Operating noise is substantially reduced by employing a proprietary double-structure outlet filter chamber, sound absorbing insulation, and a low pressure-loss HEPA filter. Sound level of all models are under 41dB (38dB during low-fan speed operation).

*Operating noise may be greater than these values in highly reflective locations.

Indoor Unit Lineup

Clean Room Air Conditioner

FXB(P)Q-P

Specifications

Type	Integrated outlet unit model			Separate outlet unit model	
MODEL	Indoor unit	FXBQ40PVE	FXBQ50PVE	FXBQ63PVE	FXBPQ63PVE
	Outlet unit	Integrated with the indoor unit			BAFH82A63
Power supply		1-phase, 220-240 V/220 V, 50/60 Hz			
Cooling capacity	Btu/h	15,400	19,100	24,200	24,200
	kW	4.5	5.6	7.1	7.1
Power consumption	kW	0.31	0.31	0.45	0.45
Intake filter efficiency *1		70% by gravimetric method			
Outlet HEPA filter efficiency *2		99.97% by DOP method *5			
Indoor unit weight	kg	140 *3		185 *3	120 *6
Casing		Galvanised steel plate			
Airflow rate (H/L)	m ³ /min	19.5/17.5		26/22.5	
	cfm	688/618		918/794	
Sound level (H/L) *4	dB(A)	44/42			
Dimensions (HxWxD)	mm	492x1,788x1,000		492x1,788x1,300	492x1,078x1,300
Outlet unit weight	kg		-		65 *3
Piping connections	Liquid (Flare)	φ6.4		φ9.5	
	Gas (Flare)	φ12.7		φ15.9	
	Drain	PT1B			
Filter(Optional)	HEPA filter	BAFH82A50		BAFH82A63	
Panel (Option)	Ceiling intake type	BYB82A50C		BYB82A63C	BYB82A63CP
	Floor-level intake type	BYB82A50W		BYB82A63W	BYB82A63WP

Note: Specifications are based on the following conditions;

•Cooling: Indoor temp.: 27°CDB, 19°CWB, Outdoor temp.: 35°CDB, Equivalent piping length: 7.5 m, Level difference: 0 m.

•Capacity of indoor unit is only for reference. Actual capacity of indoor unit is based on the total capacity index.

(See Engineering Data Book for details.)

*1: An intake air filter is only attached to the ceiling intake type.

*2: HEPA filter sold separately. The dust collection efficiency of HEPA filter is 99.97%. However, air may slightly leak around the filter when installing.

*3: Weight including HEPA filter and panel.

*4: Anechoic chamber conversion value under JIS B 8616 test conditions. Value usually increases slightly in practice due to surrounding conditions.

*5: The clean room air conditioner does not support DOP testing (leak test) based on GMP standards (Standards for Manufacturing Control and Quality Control for Medical Devices) due to slight leakage at time of product installation.

*6: Weight including panel.

*In the case of an installation in an operating theatre etc. where an air conditioner malfunction may have serious consequences, please build in redundancy with two or more outdoor units.



Warning

⊠ Because the ceiling intake type provides concentrated air conditioning that blows directly under the outlet. Accordingly, please be aware of the following.

- Sufficient heating may not be achieved near the floor or at locations far from the outlet.
- In the case of utilization in a hospital, some patients may be susceptible to cool drafts, so please ensure that they do not come directly under the outlet.
- Install multiple units using two or more outdoor unit systems for installations to rooms such as operating rooms where the failure of the air conditioner may have serious consequences.
- In order to maintain static pressure in a room, the indoor fan continues to operate even when an abnormality occurs due to the thermostat shutting off, defrost operation, protection device operation, or similar issue.
- When incorporating outdoor air from the fresh air intake, install a damper or similar device to the duct routing and have it interlocked with the indoor fan so that the outdoor air is shut out when the fan stops. The air that incorporates the suction filter may flow backward and allow dust trapped in the filter to return to the room.
- When using gas to disinfect hospital operating rooms where this unit is installed, stop operation and cover the air inlet and outlet with plastic sheets to prevent the gas from reaching and damaging the air conditioner.

⊠ Use the floor-level intake type in the following kind of locations.

- Locations in which heating of the lower part or the entire room is important.
- Locations necessitating a particularly high cleanliness factor and in which there are many people.

Slim Ceiling Mounted Duct Type

FDKS-EA/C



Standard accessory
Note: Remote controllers other than the standard accessory wireless remote controller cannot be used.

Slim and smooth design suits your shallow ceiling

- Models in the FDKS-EA series are only 700 mm in width and 21 kg in weight, made the installation easy in limited spaces. With only 200 mm in height, all models can be installed in rooms with as little as 240 mm depth between the drop ceiling and ceiling slab, making them ideal for even shallow ceilings.



	FDKS25EA	FDKS35EA	FDKS25CA	FDKS35CA
Dimensions (H x W x D)	200 x 700 x 620 mm		200 x 900 x 620 mm	
Weight	21 kg		25 kg	
Airflow rate (H)	8.7 m ³ /min	9.5 m ³ /min	10 m ³ /min	
External static pressure	30 Pa		40 Pa	

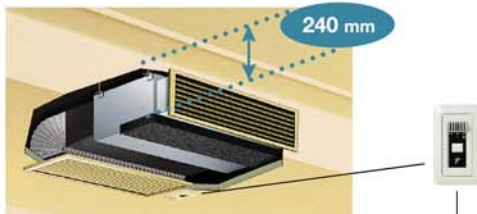

Signals from the wireless remote controller are transmitted to the signal receiver.

- Low operation sound level

(H/L/SL)

FDKS25	FDKS35	FDKS50	FDKS60
35/31/29 dB (A)	35/31/29 dB (A)	37/33/31 dB (A)	38/34/32 dB (A)

- Home Leave Operation prevents large increase or decrease in the indoor temperature by continuing operation* while someone is sleeping or left the house. This means that an air-conditioned welcome awaits when someone wakes up or returns. It also means that the indoor temperature can quickly return to the preferred comfort setting.

* Home Leave Operation can set to any temperature from 18 to 32°C for cooling operation.

* Home Leave Operation function must be set by using the remote controller when going to sleep or leaving the house, and after waking up or returning home.

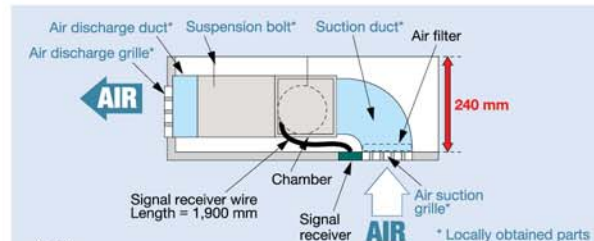

Note:

- To prevent an increase of the operation noise, avoid installing the air suction grille directly below the suction chamber.
- Grilles, piping connections, ducts, and installation parts should be obtained locally. Slim Ceiling Mounted Duct type models do not have drain-up pumps.
- The signal receiver unit must be located near the air suction inlet, because the unit includes a sensor that detects room temperature.

Specifications

MODEL		FDKS25EAVMB	FDKS35EAVMB	FDKS25CAVMB	FDKS35CAVMB	FDKS50CVMB	FDKS60CVMB
Power supply		1-phase, 220-240 V/220-230 V, 50/60 Hz					
Airflow rates (H)	m ³ /min (cfm)	8.7 (307)		9.5 (335)	10.0 (353)	12.0 (424)	16.0 (565)
Sound levels (H/L/SL)*	dB (A)	35/31/29		37/33/31		38/34/32	
Fan speed		5 steps, quiet and automatic					
Temperature control		Microcomputer control					
Dimensions (HxWxD)	mm	200x700x620		200x900x620		200x1,100x620	
Machine weight	kg	21		25	27	30	
Piping connections	Liquid (Flare)			φ6.4			
	Gas (Flare)			φ9.5		φ12.7	
	Drain	VP20 (External Dia. 26/Internal Dia. 20)					
Heat insulation		Both liquid and gas pipes					
External static pressure	Pa	30				40	

Note: * The operation sound level values represent those for rear-suction operation and an external static pressure of 30 Pa for FDKS-EA and 40 Pa for FDKS-C. Sound level values for bottom-suction operation can be obtained by adding 6 dB (A) for FDKS-EA and 5 dB (A) for FDKS-C.

Indoor Unit Lineup



Wall Mounted Type

FTKJ-N

Elegant appearance with European style



Standard accessory



- **Elegant Appearance with Curved Panel**
 - The sleek design of the FTKJ-N indoor unit features a uniquely European style. This elegant body houses state-of-the-art technology which delivers superior performance. The FTKJ-N series offers a versatile choice for home-owners, designers and architects alike.



- **Comfort Airflow Mode**
 - Comfort Airflow Mode prevents uncomfortable impacts from blowing directly to a person's body. During cooling operation, the flap moves upwards to prevent cold impacts.



- **Two-Area Intelligent Eye**
 - A combination of Comfort Airflow Mode and Intelligent Eye directs airflow away from people to avoid impacts. If there is no movement in a room for 20 minutes, Intelligent Eye automatically adjusts the set temperature by approximately 2°C to save energy.

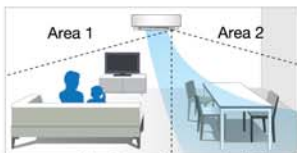

If a person is detected in area 1, airflow is directed away from him/her.

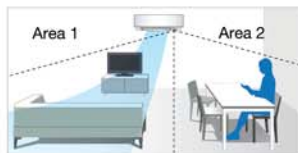

If a person is detected in area 2, airflow is directed away from him/her.

- **3D Airflow**
 - 3D Airflow combines Vertical and Horizontal Auto-Swing to reduce indoor temperature fluctuation. This function circulates air to every part of a room for uniform cooling, even for large spaces. To start 3D Airflow, push both the Vertical and Horizontal Auto-Swing buttons. The flaps and louvers swing in turn.

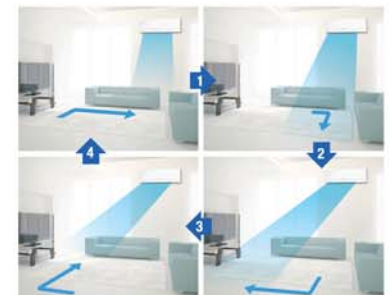

The flaps and louvers swing in turn, expands the comfort zone.

Specifications

MODEL		FTKJ25NVMW	FTKJ25NVMS	FTKJ35NVMW	FTKJ35NVMS	FTKJ50NVMW	FTKJ50NVMS
Power supply		1-phase, 220-240 V/220-230 V, 50/60 Hz					
Front panel colour		White	Silver	White	Silver	White	Silver
Airflow rates (H)	m ³ /min(cfm)	8.9 (313)		10.9 (385)			
Sound levels (H/L/SL)	dB (A)	38/25/19		45/26/20		46/35/29	
Fan speed		5 steps, quiet and automatic					
Temperature control		Microcomputer control					
Dimensions (H×W×D)		mm 303×998×212					
Machine weight		kg 12					
Piping connections	Liquid (Flare)	mm ϕ6.4					
	Gas (Flare)	mm ϕ9.5		mm ϕ12.7			
	Drain	mm ϕ18.0					
Heat insulation		Both liquid and gas pipes					

Indoor Unit Lineup

Wall Mounted Type

FTKS-D/B/F



FTKS25D / FTKS35D



Standard accessory*

FTKS50B



Standard accessory*

FTKS50F / FTKS60F / FTKS71F



Standard accessory*

* Remote controllers other than the standard accessory wireless remote controller cannot be used.

Stylish flat panel harmonises with your interior décor

Wall Mounted indoor units achieve quiet sound levels of 22 dB (A).

(H/L/SL)

FTKS25D	FTKS35D	FTKS50F	FTKS60F	FTKS71F
37/25/22 dB (A)	39/26/23 dB (A)	43/34/31 dB (A)	45/36/33 dB (A)	46/37/34 dB (A)

- **Intelligent Eye** with its infrared sensor automatically controls air conditioner operation according to human movement in a room. When there is no movement, it adjusts the temperature by 2°C for energy savings.



When you are in the room



When you go out

- **3-D Airflow** combines Vertical and Horizontal Auto-Swing to circulate air to every part of a room for uniform cooling of even large spaces.

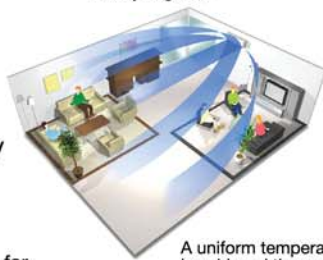

A uniform temperature is achieved throughout the entire room.

* This function is available for FTKS50/60/71F.

• Titanium Apatite Deodorising Filter

While the filter's micron-level fibres trap dust, titanium apatite effectively adsorbs odours and allergens, as well as deodorises odours.



This filter is not a medical device. Benefits such as the adsorption of odours and allergens and deodorisation of odours are only effective for substances which are directly attached to the Titanium Apatite Deodorising Filter.

Specifications

MODEL	FTKS25DVM	FTKS35DVM	FTKS50BVM	FTKS50FVM	FTKS60FVM	FTKS71FVM	
Power supply	1-phase, 220-240 V/220-230 V, 50/60 Hz						
Front panel colour	White						
Airflow rates (H)	m ³ /min (cfm)	8.7 (307)	8.9 (314)	11.4 (402)	14.7 (519)	16.2 (572)	17.4 (614)
Sound levels (H/L/SL)	dB (A)	37/25/22	39/26/23	44/35/32	43/34/31	45/36/33	46/37/34
Fan speed	5 steps, quiet and automatic						
Temperature control	Microcomputer control						
Dimensions (HxWxD)	mm	283x800x195		290x795x238		290x1,050x238	
Machine weight	kg	9				12	
Piping connections	Liquid (Flare)	φ6.4					
	Gas (Flare)	φ9.5		φ12.7		φ15.9	
	Drain	φ18.0					
Heat insulation	Both liquid and gas pipes						

BP Units for Connection to Residential Indoor Units

Connectable to Residential Indoor Units

BP units allow **VRV** systems to be connected to Daikin's stylish and quiet residential indoor units.



Quiet Operating Sound

Expansion valves tend to create refrigerant passing noise. However, this noise can be reduced by installing the valves in BP units. The units can be fitted inside the ceiling or roof-space far from an indoor unit. Some Daikin residential indoor units also provide minimum sound levels of just 19 dB(A). Together these features ensure your system continues to operate as quietly as possible.

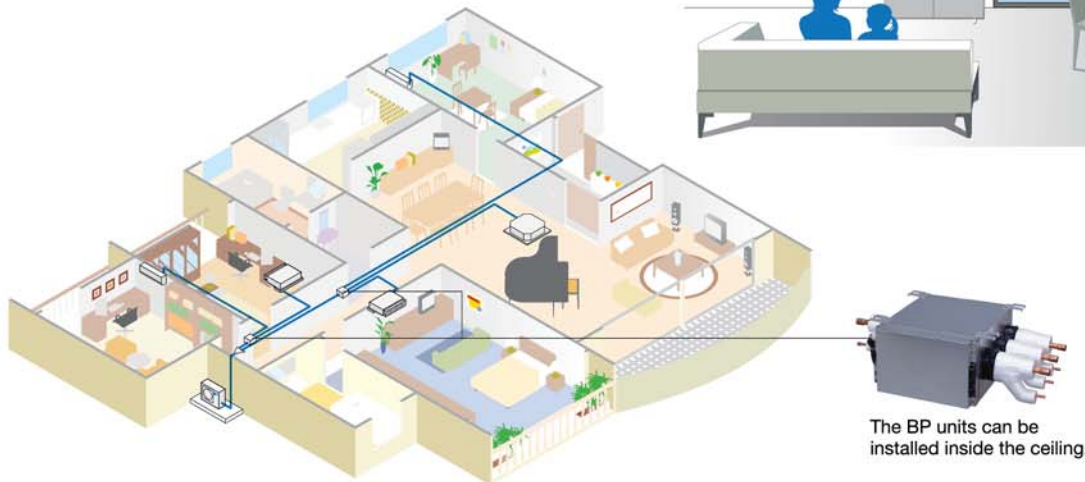

The BP units can be installed inside the ceiling.

Specifications



BPMKS967A3



BPMKS967A2

MODEL				BPMKS967A3	BPMKS967A2
Power supply				1-phase, 220-240 V/220-230 V, 50/60 Hz	
Number of ports				3 (connectable to 1-3 indoor units)	2 (connectable to 1-2 indoor units)
Power consumption		W	10		
Running current		A	0.05		
Dimensions (HxWxD)				180X294 (+356*)X350	
Machine weight		kg	8	7.5	
Number of wiring connections				3 for power supply (including earth wiring), 2 for interunit wiring (outdoor unit-BP, BP-BP), 4 for interunit wiring (BP-indoor unit)	
Piping connections (Brazing)	Liquid	Main	mm	φ9.5X1	
		Branch	mm	φ6.4X3	φ6.4X2
	Gas	Main	mm	φ19.1X1	
		Branch	mm	φ15.9X3	φ15.9X2
Heat insulation				Both liquid and gas pipes	
Connectable indoor units				2.0 kW class to 7.1 kW class	
Min. rated capacity of connectable indoor units		kW	2.0		
Max. rated capacity of connectable indoor units		kW	20.8	14.2	

Note: * Total auxiliary piping length.

Air Handling Unit

■ Air Handling Unit

Integrate your air handling unit in a total solution for large size spaces such as factories and large stores.

AHUR

Capacity range : 6 – 120 HP



- Easy design and installation
 - The system is easy to design and install since no additional water systems such as boilers, tanks and gas connections etc are required.
- Inverter controlled units
- Control of air temperature via standard Daikin wired remote control for standard series



System overview



— Daikin communication wire (F1, F2 communication)
— Other communication wire

— Liquid pipe
— Gas pipe

Daikin air handling units can be connected to VRF systems. This combination can be built to order as a system. Outdoor air series is also possible. Please contact your local sales office for details.

Air Treatment Equipment Lineup

Daikin's air treatment systems creating a higher air quality environment

Components of Indoor Air Quality

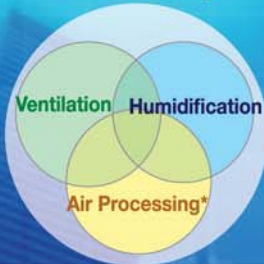

*Refers to bringing outdoor air to near indoor temperature and delivering to a room.

A recent trend rapidly gaining popularity is for air treatment to be required as well as air conditioning. Daikin's Outdoor-Air Processing Unit can combine fresh air treatment and air conditioning, supplied from a single system. It adjusts the temperature of air from outdoors using a fixed discharge temperature control. Along with Outdoor-Air Processing Units, we also offer Heat Reclaim Ventilator systems. The Heat Reclaim Ventilator VAM-GJ series units in particular have been praised for their compactness, energy conservation and extensive operation range of outdoor temperatures. This series provides higher enthalpy efficiency^{★1}, due to the greatly enhanced performance of the thin film element. Furthermore, improved external static pressure^{★2} offers more flexibility for installation. The Heat Reclaim Ventilator VKM-GAM series units, equipped with a DX-coil and a humidifier, provide further advanced features, such as temperature adjustment to suit conditions indoors and to prevent cold air from blowing on people directly during heating operation. The series also realises significant energy savings by exercising heat recovery.

★1 For models: VAM150/250/350/650/800/1000/2000GJVE

★2 For models: VAM150/350/500GJVE

		Outdoor-Air Processing Unit	Heat Reclaim Ventilator			
			VKM-GAM Type	VKM-GA Type	VAM-GJ Type	
Connections with VRV systems	Refrigerant Piping	Connectable	Connectable		Not connectable	
	Wiring	Connectable	Connectable		Connectable	
	After-cool & After-heat Control	Available	Available		Not available	
Heat Exchange Element		—	Energy savings obtained		Energy savings obtained	
Humidifier		—	Fitted	—	—	
High Efficiency Filter		Option	Option		Option	
Ventilation System		Air supply only	Air supply & air exhaust		Air supply & air exhaust	
Power Supply		220-240 V, 50 Hz	220-240 V, 50 Hz		220-240 V/220 V, 50 Hz/60 Hz	
Airflow Rate					150 m ³ /h	
					250 m ³ /h	
					350 m ³ /h	
				500 m ³ /h		500 m ³ /h
						650 m ³ /h
				800 m ³ /h		800 m ³ /h
			1080 m ³ /h 1680 m ³ /h 2100 m ³ /h	1000 m ³ /h		1000 m ³ /h 1500 m ³ /h 2000 m ³ /h

*Refers to bringing outdoor air to near indoor temperature and delivering to a room.

Air Treatment Equipment Lineup

Outdoor-Air Processing Unit

Combine fresh air treatment and air conditioning, supplied from a single system.

Lineup

Model Name	FXMQ125MFV1	FXMQ200MFV1	FXMQ250MFV1
Capacity Index	125	200	250



Fresh air treatment and air conditioning can be achieved with a single system by using heat pump technology—without the usual troublesome air supply and air discharge balance design. Fan coil units for air conditioning and an outdoor-air processing unit can be connected to the same refrigerant line. This results in enhanced design flexibility and significant reduction in total system costs.

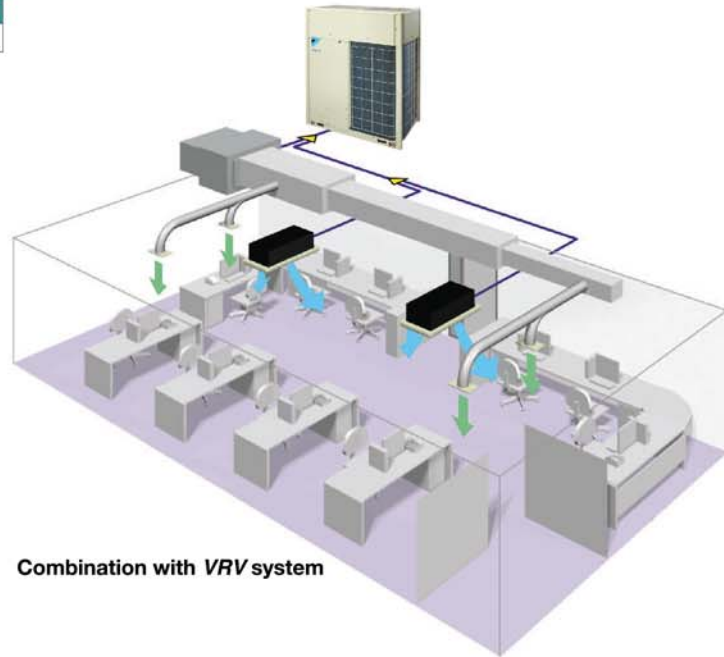

Combination with VRV system

Air conditioning and outdoor air processing can be accomplished using a single system.

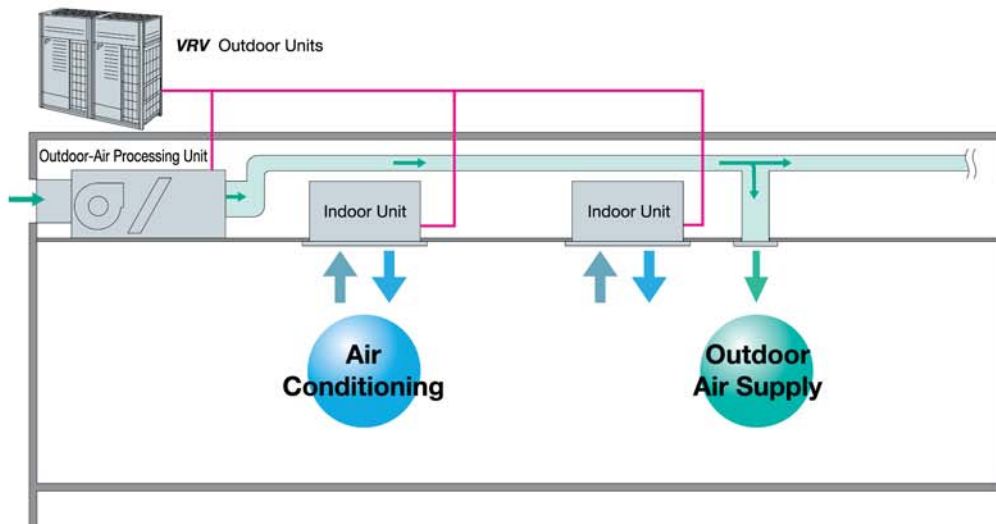

Connection Conditions

The following restrictions must be observed in order to maintain the indoor units connected to the same system.

- When outdoor-air processing units are connected, the total connection capacity index must be 50% to 100% of the capacity index of the outdoor units.
- When outdoor-air processing units and standard indoor units are connected, the total connection capacity index of the outdoor-air processing units must not exceed 30% of the capacity index of the outdoor units.
Because connection is possible depending on conditions even when the capacity index of outdoor-air processing units exceeds 30% of the capacity index of the outdoor units, contact your local distributor.
- Outdoor-air processing units can be used without indoor units.

- The unit introduces outdoor air and adjusts the outdoor air temperature via fixed discharge temperature control, thereby reducing the air conditioning load.
 - * The system can operate with outdoor-air temperatures ranging from -5 to 43°C. Heating performance is somewhat adversely affected when the outdoor-air temperature is 0°C or below.
 - * When shipped from the factory, the thermostat is set at 18°C for cooling. The set temperature can be varied within the range of 13–25°C during cooling operation, in the local setting mode using the wired remote controller. The temperature, however, is not displayed on the remote controller.
 - * While in machine protection mode and depending on outdoor air conditions, discharge air temperature may not be at the set temperature.
 - * The fan stops when operating in defrosting, oil returning and hot start operations. The fan may stop due to mechanical protection control.
- Ceiling mounted duct units with three different capacities are available. These can be connected to **VRV** series outdoor units to meet a variety of different requirements.

Airflow rate

FXMQ125MFV1	1,080 m ³ /h
FXMQ200MFV1	1,680 m ³ /h
FXMQ250MFV1	2,100 m ³ /h

- Optional equipment includes long-life filters.
- Compatible with outdoor temperatures from -5°C to 43°C.

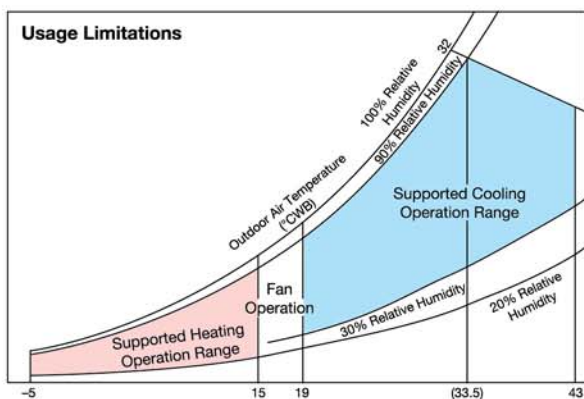

- Note:
1. The data shown in the graph illustrates the supported operation ranges under the following conditions.
Indoor and Outdoor Unit
Effective piping length: 7.5 m
Height differential: 0 m
 2. The discharge temperature can be set using the remote controller. However, the actual temperature may not match the temperature setting under some circumstances due to the outdoor-air processing load or mechanical protection controls.
 3. The system will not operate in fan mode when the outdoor air temperature is 5°C or below.

- High-performance filters with dust collection efficiencies (JIS calorimetry) of 90% and 65% are also available as options.

- For the **VRV** system, a variety of control systems can be deployed, including remote control from distances of up to 500 m.



BRC1E63
Navigation Remote Controller (Wired remote controller) (option)

- * Group control is not possible between this unit and standard type indoor units. Remote controllers connect to each unit separately.

- The “self-diagnosis function” indicates the occurrence and nature of abnormalities in the system by displaying codes on the remote controller.

- A central control system compatible with the **VRV** system can be installed.



DCS302CA61
Central remote controller (option)

- * It is not possible to change the discharge air temperature settings from the central control system.
- * Do not associate this equipment in areas which standard indoor units are installed, as central control cannot be used with them.

- With the **VRV** system, the equipment employs the “super wiring system” so that the wiring linking the indoor and outdoor units can also be utilised for central control.

Note:

- Linked control of the product and the Heat Reclaim Ventilator is not supported.
- This equipment is intended for the treatment of outdoor air only. It is not to be used for maintaining indoor air temperature, installing or use with standard indoor units. Be sure to position the air discharge openings of the product in positions where the airflow will not blow on people directly. When outdoor-air processing is in excess, the unit switches to thermo-off mode, and outdoor air flows into the room directly.
- For outdoor ducts, be sure to provide heat insulation to prevent condensation.
- Group control of the product and standard indoor units is not supported. A separate remote controller should be connected to individual unit.
- The system will not operate in fan mode when the outdoor air temperature is 5°C or below.
- If the product is utilised to operate 24 hours a day, maintenance (part replacement, etc.) must be performed periodically.
- Temperature setting and Power Proportional Distribution (PPD) are not possible even if the intelligent Touch Controller or the intelligent Touch Manager is installed.
- The remote controller wired to the outdoor-air processing unit must not be set as the master remote controller. Otherwise, when set to “Auto,” the operation mode will switch according to the outdoor air conditions, regardless of the indoor temperature.

Air Treatment Equipment Lineup

STANDARD SPECIFICATIONS

Indoor unit

Type		Ceiling Mounted Duct Type			
Model		FXMQ125MFV1	FXMQ200MFV1	FXMQ250MFV1	
Power supply		1-phase 220-240 V (also required for indoor units), 50 Hz			
Cooling capacity *1	Btu/h	47,800	76,400	95,500	
	kW	14.0	22.4	28.0	
Power consumption		kW	0.359	0.548	0.638
Casing		Galvanised steel plate			
Dimensions (HxWxD)		mm	470X744X1,100	470X1,380X1,100	
Fan	Motor output	kW	0.380		
	Airflow rate	m ³ /min	18	28	35
		cfm	635	988	1,236
	External static pressure	220V/240V Pa	185/225	225/275	205/255
Air filter		*2			
Refrigerant piping	Liquid	mm	φ 9.5 (flare)		
	Gas	mm	φ 15.9 (flare)	φ 19.1 (brazing)	φ 22.2 (brazing)
	Drain	mm	PS1B female thread		
Machine weight		kg	86	123	
Sound level *3	220V/240V	dB(A)	42/43	47/48	
Connectable outdoor units *4			6 HP and above	8 HP and above	10 HP and above
Operation range (Fan mode operation between 15 and 19°C)		Cooling	19 to 43°C		
Range of the discharge temperature *5		Cooling	13 to 25°C		

Notes: *1. Specifications are based on the following conditions;

- Cooling: Outdoor temp. of 33°CDB, 28°CWB (68% RH), and discharge temp. of 18°CDB.
- Equivalent reference piping length: 7.5 m (0 m horizontal)

*2. An intake filter is not supplied, so be sure to install the optional long-life filter or high-efficiency filter. Please mount it in the duct system of the suction side.

Select a dust collection efficiency (gravity method) of 50% or more.

*3. Anechoic chamber conversion value, measured at a point 1.5 m downward from the unit centre. These values are normally somewhat higher during actual operation as a result of ambient conditions.

*4. It is possible to connect to the outdoor unit if the total capacity of the indoor units is 50% to 100% of the capacity index of the outdoor unit.

*5. Local setting mode is not displayed on the remote controller.

• This equipment cannot be incorporated into the remote group control of the VRF system.

OPTIONS

Indoor unit

Model		FXMQ125MFV1	FXMQ200MFV1	FXMQ250MFV1
Operation/control	Operation remote controller	BRC1E63/BRC1C62		
	Central remote controller	DCS302CA61		
	Unified ON/OFF controller	DCS301BA61		
	Schedule timer	DST301BA61		
	Wiring adaptor for electrical appendices (1)	KRP2A61		
	Wiring adaptor for electrical appendices (2)	KRP4AA51		
Filters	Long-life replacement filter	KAFJ371L140		KAFJ371L280
	High-efficiency filter	Colourimetric method 65%	KAFJ372L140	KAFJ372L280
		Colourimetric method 90%	KAFJ373L140	KAFJ373L280
	Filter chamber *1	KDJ3705L140		KDJ3705L280
Drain pump kit		KDU30L250VE		
Adaptor for wiring		KRP1B61		

Note: *1. Filter chamber has a suction-type flange. (Main unit does not.)

- Dimensions and weight of the equipment may vary depending on the options used.
- Some options may not be usable due to the equipment installation conditions, so please confirm prior to ordering.

• Some options may not be used in combination.

• Operating sound may increase somewhat depending on the options used.

DIMENSIONS

FXMQ125/200/250MFV1

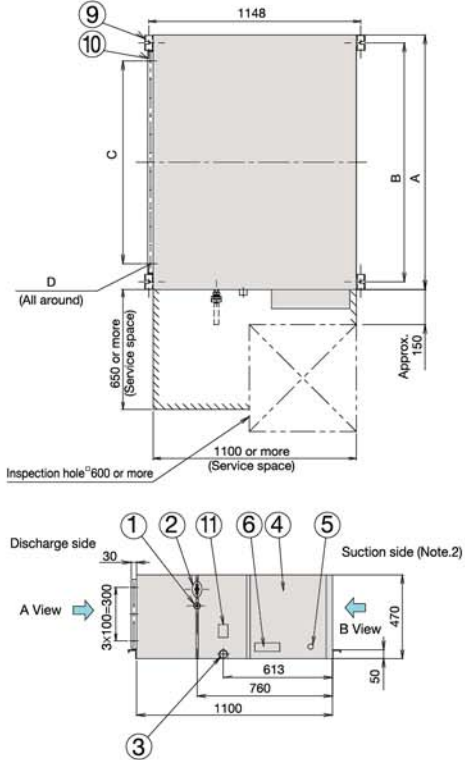

*These diagrams are based on FXMQ200 and FXMQ250MFV1.

Local connection piping size

Model	Gas piping diameter	Liquid piping diameter
FXMQ125MFV1	φ15.9	φ9.5
FXMQ200MFV1	φ19.1 attached piping	φ9.5
FXMQ250MFV1	φ22.2 attached piping	φ9.5

Table of dimensions

Model	A	B	C	D
FXMQ125MFV1	744	685	5X100=500	20-φ4.7 hole
FXMQ200MFV1	1380	1296	11X100=1100	32-φ4.7 hole
FXMQ250MFV1	1380	1296	11X100=1100	32-φ4.7 hole

Notes:

- The attached piping in the diagram is for FXMQ200MFV1 and FXMQ250MFV1 only. The gas piping connection port (② in the diagram) has a different bore form with FXMQ125MFV1.
- An air filter is not supplied with this unit. Be sure to mount an air filter in the suction side. [Use a filter with dust collection efficiency of at least 50% (gravimetric method). This is available as an option.]
- For outdoor ducts, be sure to provide heat insulation to prevent condensation.

- ① Liquid pipe connection
- ② Gas pipe connection
- ③ Drain piping connection
- ④ Electric parts box
- ⑤ Ground terminal
- ⑥ Name plate
- ⑦ Power supply wiring connection
- ⑧ Transmission wiring connection
- ⑨ Hanger bracket
- ⑩ Discharge companion flange
- ⑪ Water supply port
- ⑫ Attached piping (Note. 1)

FXMQ200/250MFV1

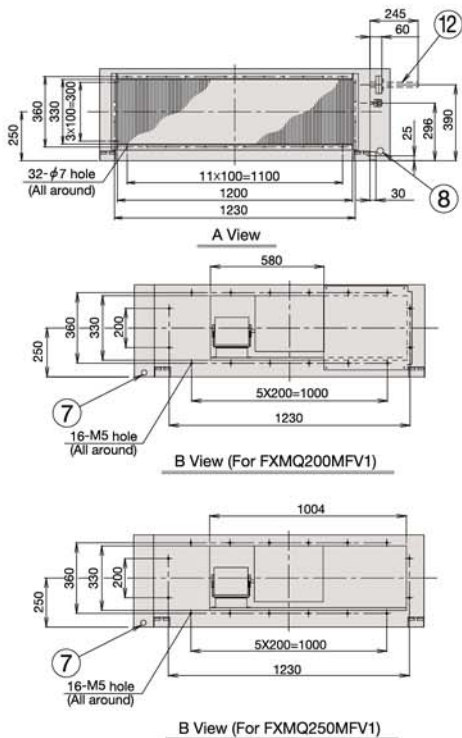

FXMQ125MFV1

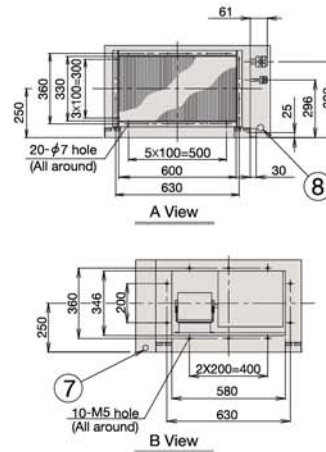

Air Treatment Equipment Lineup

Heat Reclaim Ventilator with DX-Coil and Humidifier – VKM series

The Heat Reclaim Ventilator lineup features the DX-coil in response to recently diversifying outdoor air introduction requirements.

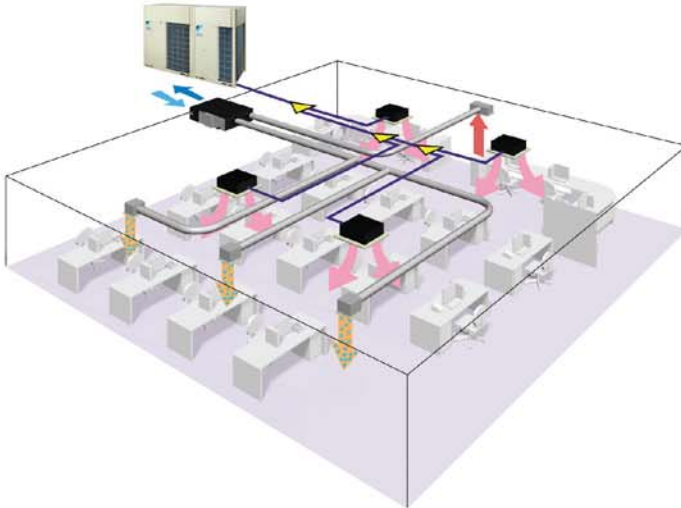

Lineup

With DX Coil & Humidifier Type			
Model Name	VKM50GAMV1	VKM80GAMV1	VKM100GAMV1
Capacity Index	31.25	50	62.5

With DX Coil Type			
Model Name	VKM50GAV1	VKM80GAV1	VKM100GAV1
Capacity Index	31.25	50	62.5



Efficient outdoor air introduction is possible

The Heat Reclaim Ventilator (VKM series) series introduces fresh outdoor air with minimum heat losses, with a wide variety of features cater to customer requirements.

Humidifier

The lineup includes models with a humidifier, in response to diverse customer requirements. (VKM50/80/100GAMV1 only)

DX-coil

The Heat Reclaim Ventilator features DX-coil that contributes to the prevention of cold airflow colliding people directly during heating operation, due to the after-cool, after-heat operations done beforehand.

High static pressure

High external static pressure means enhanced design flexibility.

Air conditioning and outdoor air processing can be accomplished using a single system.

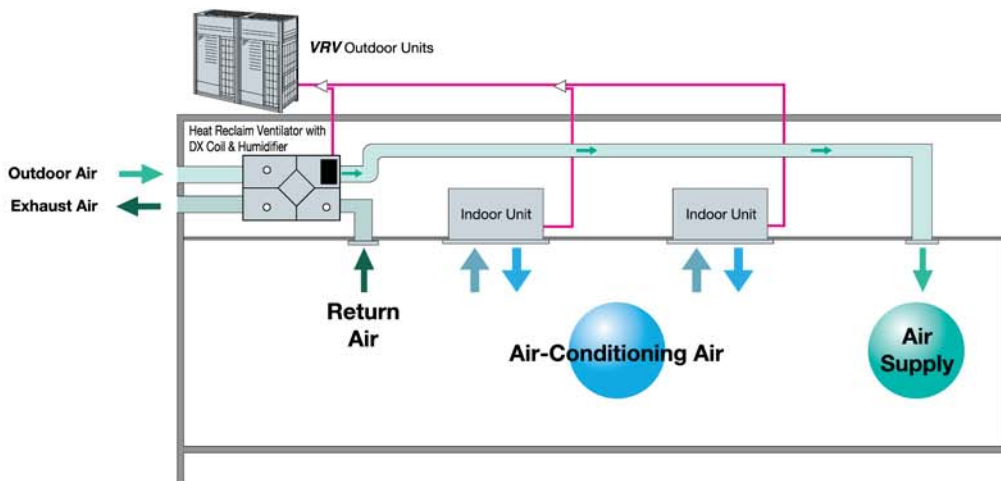

Connection Conditions

The following restrictions must be observed in order to maintain the indoor units connected to the same system.

- When the Heat Reclaim Ventilator VKM series units are connected, the total connection capacity index must be 50% to 130% of the capacity index of the outdoor units.

A compact unit packed with Daikin's cutting-edge technologies.

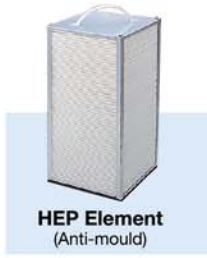
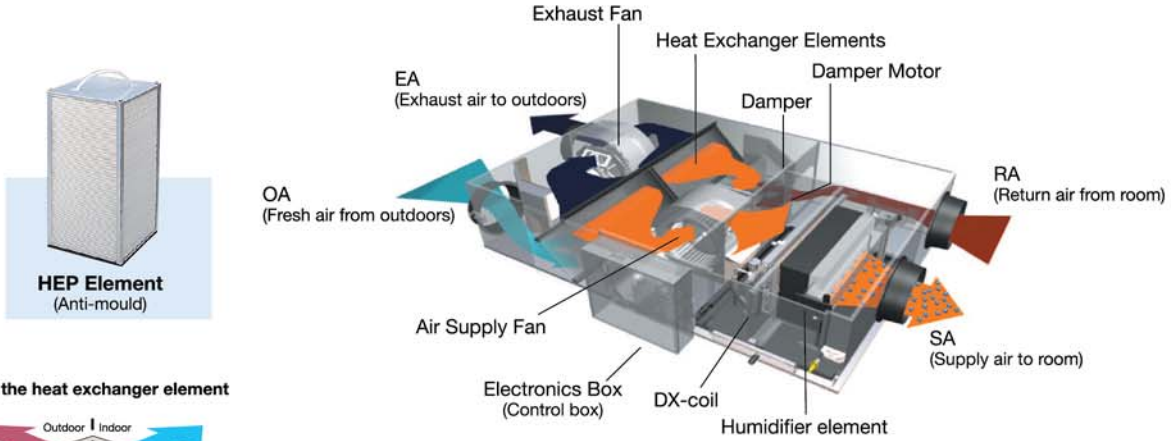

Operation of the heat exchanger element

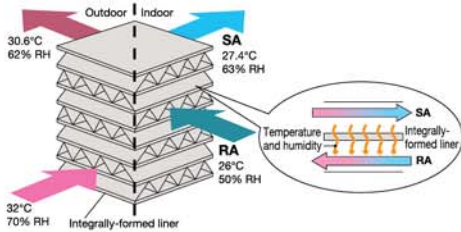

Heating and humidification process

Structure of VKM series

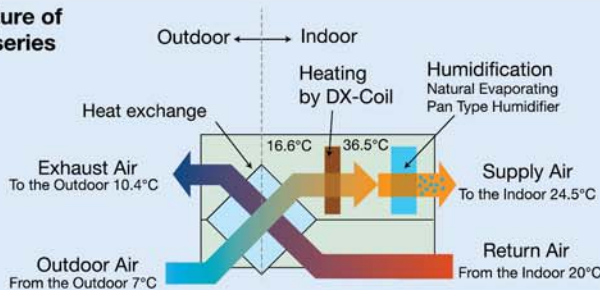

Humidification: 5.4kg/h (VKM100GAMV1)

The Outdoor air is heated from 16.6°C to 36.5°C with DX-coil, Natural Evaporating Pan Type Humidifier is passed and humidification capacity is improved.

DX-Coil: Heat Exchanger which heating or cooling the air by **VRV** outdoor unit's refrigerant.

Efficient outdoor air introduction with heat exchanger and cooling/heating operation.

Indoor unit with outdoor air treatment

Using outdoor air, the temperature can be brought near room temperature with minimal cooling capacity through the use of outdoor air.

Other features

- Integrated system includes ventilation and humidifying operations.
- Ventilation, cooling/heating and humidifying are possible with one remote controller.

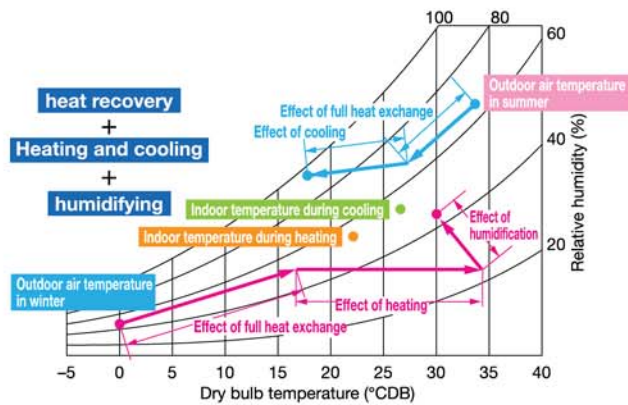

Air Treatment Equipment Lineup

SPECIFICATIONS

MODEL				VKM50GAMV1*	VKM80GAMV1*	VKM100GAMV1*	VKM50GAV1	VKM80GAV1	VKM100GAV1
Refrigerant				R-410A					
Power Supply				1-phase, 220-240 V, 50 Hz					
Airflow Rate & Static Pressure (Note 7)	Ultra-high	Airflow rate	m ³ /h	500	750	950	500	750	950
		Static pressure	Pa	160	140	110	180	170	150
	High	Airflow rate	m ³ /h	500	750	950	500	750	950
		Static pressure	Pa	120	90	70	150	120	100
	Low	Airflow rate	m ³ /h	440	640	820	440	640	820
		Static pressure	Pa	100	70	60	110	80	70
Power Consumption	Heat exchange mode	Ultra-high	W	560	620	670	560	620	670
		High	W	490	560	570	490	560	570
		Low	W	420	470	480	420	470	480
	Bypass mode	Ultra-high	W	560	620	670	560	620	670
		High	W	490	560	570	490	560	570
		Low	W	420	470	480	420	470	480
Fan Type				Sirocco Fan					
Motor Output				kW					
				0.280 x 2	0.280 x 2	0.280 x 2	0.280 x 2	0.280 x 2	0.280 x 2
Sound Level (Note 5) (220/230/240 V)	Heat exchange mode	Ultra-high	dB(A)	37/37.5/38	38.5/39/40	39/39.5/40	38/38.5/39	40/41/41.5	40/40.5/41
		High	dB(A)	35/35.5/36	36/37/37.5	37/37.5/38	36/36.5/37	37.5/38/39	38/38.5/39
		Low	dB(A)	32/33/34	33/34/35.5	34/34.5/35.5	33.5/34.5/35.5	34.5/36/37	35/36/36.5
	Bypass mode	Ultra-high	dB(A)	37/37.5/38	38.5/39/40	39/39.5/40	38/38.5/39	40/41/41.5	40/40.5/41
		High	dB(A)	35/35.5/36	36/37/37.5	37/37.5/38	36/36.5/37	37.5/38/39	38/38.5/39
		Low	dB(A)	32/33/34	33/34/35.5	34/34.5/35.5	33.5/34.5/35.5	34.5/36/37	35/36/36.5
Humidification Capacity (Note 4)				kg/h					
				2.7	4.0	5.4	—	—	—
Temp. Exchange Efficiency	Ultra-high			76	78	74	76	78	74
	High			76	78	74	76	78	74
	Low			77.5	79	76.5	77.5	79	76.5
Enthalpy Exchange Efficiency (Cooling)	Ultra-high			64	66	62	64	66	62
	High			64	66	62	64	66	62
	Low			67	68	66	67	68	66
Enthalpy Exchange Efficiency (Heating)	Ultra-high			67	71	65	67	71	65
	High			67	71	65	67	71	65
	Low			69	73	69	69	73	69
Casing				Galvanised Steel Plate					
Insulating Material				Self-Extinguishable Urethane Foam					
Heat Exchanging System				Air to Air Cross Flow Total Heat (Sensible + Latent Heat) Exchange					
Heat Exchanger Element				Specially Processed Nonflammable Paper					
Air Filter				Multidirectional Fibrous Fleeces					
DX-coil Capacity	Cooling (Note 2)			2.8	4.5	5.6	2.8	4.5	5.6
	Heating (Note 3)			3.2	5.0	6.4	3.2	5.0	6.4
Dimensions	Height			387	387	387	387	387	387
	Width			1,764	1,764	1,764	1,764	1,764	1,764
	Depth			832	1,214	1,214	832	1,214	1,214
Connection Duct Diameter				mm					
				φ200	φ250		φ200	φ250	
Machine Weight	Net			102	120	125	96	109	114
	Gross (Note 8)			107	129	134	—	—	—
Unit Ambient Condition				0°C-40°CDB, 80%RH or less					
				-15°C-40°CDB, 80%RH or less					
				0°C-40°CDB, 80%RH or less					

Note: 1. Cooling and heating capacities are based on the following conditions. Fan is based on High and Ultra-high.
 When calculating the capacity as indoor units, use the following figures:
 VKM50GAMV1/GV1: 3.5 kW, VKM80GAMV1/GV1: 5.6 kW, VKM100GAMV1/GV1: 7.0 kW
 2. Indoor temperature: 27°CDB, 19°CWB, Outdoor temperature: 35°CDB
 3. Indoor temperature: 20°CDB, Outdoor temperature: 7°CDB, 6°CWB
 4. Humidifying capacity is based on the following conditions:
 Indoor temperature: 20°CDB, 15°CWB, Outdoor temperature: 7°CDB, 6°CWB
 5. The operating sound measured at the point 1.5 m below the centre of the unit is converted to that measured in an anechoic chamber built in accordance with the JIS C 1502 conditions. The actual operating sound varies depending on the surrounding conditions (near running unit's sound, reflected sound and so on) and is normally higher than this value.
 For operation in a quiet room, it is required to take measures to lower the sound.
 For details, refer to the Engineering Data.
 6. The noise level at the air discharge port is about 8-11 dB(A) or higher than the unit's operating sound.
 For operation in a quiet room, it is required to take measures to lower the sound.
 7. Airflow rate can be changed over to Low mode or High mode.
 8. In case of holding full water in humidifier.
 9. OA: fresh air from outdoor, RA: return air from room.
 10. Specifications, design and information here are subject to change without notice.
 11. Power consumption and efficiency depend on the above value of airflow rate.

12. Temperature exchange efficiency is the mean value for Cooling and Heating. Efficiency is measured under the following condition: Ratio of rated external static pressure outdoor to indoor is kept constant at 7 to 1.
 13. In heating operation, freezing of the outdoor unit's coil increases. Heating capability decreases and the system goes into defrost operation. During defrost operation, the fans of the unit continues driving (factory setting). The purpose of this is to maintain the amount of ventilation and humidifying.
 14. When connecting with a **VRV** system heat recovery outdoor unit and bringing the RA (exhaust gas intake) of this unit directly in from the ceiling, connect to a BS unit identical to the **VRV** indoor unit (master unit), and use group-linked operation. (See the Engineering Data for details.)
 15. When connecting the indoor unit directly to the duct, always use the same system on the indoor unit as with the outdoor unit, perform group-linked operation, and make the direct duct connection settings from the remote controller. (Mode No. "17 (27)" - First code No. "5" - Second code No. "6".) Also, do not connect to the outlet side of the indoor unit. Depending on the fan strength and static pressure, the unit might back up.
 « Feed clean water (city water, tap water or equivalent). Dirty water may clog the valve or cause dirt deposits in the water container, resulting in poor humidifier performance. (Never use any cooling tower water and heating-purpose water.)
 Also, if the supply water is hard water, use a water softener because of short life.
 * Life of humidifying element is about 3 years (4,000 hours) under the supply water conditions of hardness: 150 mg/l. (Life of humidifying element is about 1 year (1,500 hours) under the supply water conditions of hardness: 400 mg/l.)
 Annual operating hours: 10 hours/day x 26 days/month x 5 months = 1,300 hours

DIMENSIONS

VKM50/80/100GA(M)V1

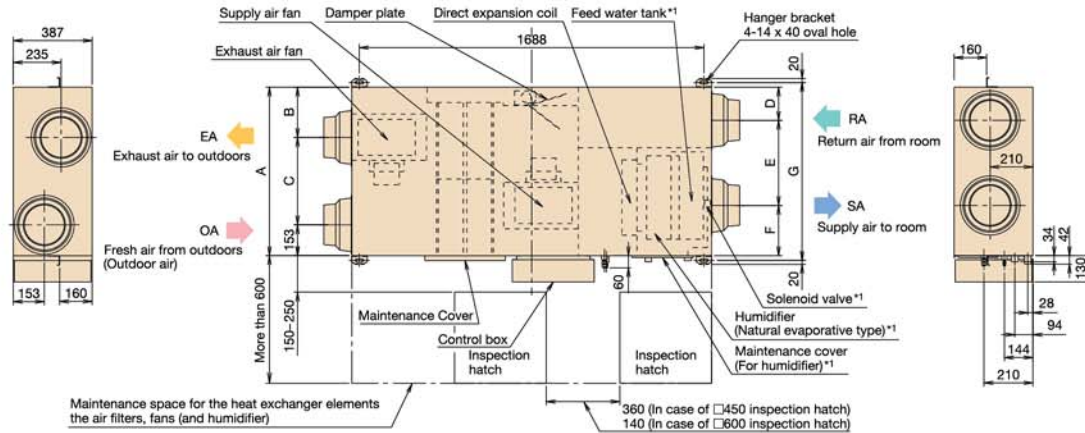

	VKM50GA(M)V1	VKM80/100GA(M)V1
A	832	1,214
B	248	439
C	431	622
D	164	183
E	420	592
F	248	439
G	878	1,262
H	137	89
I	137	89
J	ø196	ø246
K	ø250	ø263

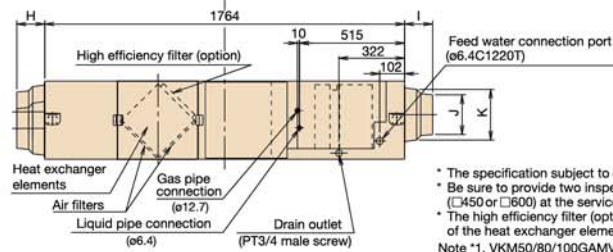

* The specification subject to change without notice.
 * Be sure to provide two inspection hatch. (□450 or □600) at the service side of filters and elements.
 * The high efficiency filter (option) can be attached to the SA surface of the heat exchanger elements.
 Note *1. VKM50/80/100GAMV1 only.

OPTIONS

Item	Type	VKM50/80/100GA(M)V1													
Remote controller	Residential central remote controller	BRC1E63/BRC1C62 *1													
	Central remote controller	DCS303A51 *2													
	Unified ON/OFF controller	DCS302CA61													
	Schedule timer	DCS301BA61													
Wiring adaptor for electrical appendices	For humidifier running ON signal output	KRP2A61													
	For heater control kit	KRP50-2													
		BRP4A50													
For wiring (VRV indoor unit)	Type	FXFSQ-A	FXZQ-M	FXCQ-M	FXEQ-A	FXDQ-PD	FXSQ-PA	FXMQ-PA	FXMQ-MA	FXUQ-A	FXHQ-MA	FXAQ-P	FXLQ-MA	FXVQ-N	FXBQ-P
		FXFQ-A				FXDQ-ND							FXNQ-MA		FXBPQ-P
		KRP1C11A*	KRP1BA57*	KRP1B61*	—	KRP1B56*	KRP1C64*	KRP1C64*	KRP1B61	KRP1C67	KRP1BA54	—	KRP1B61	KRP1C67	KRP1B61
Installation box for adaptor PCB*		Note 2, 3	Note 4, 5	Note 2, 3	—	Note 4, 5	Note 2, 3	Note 2, 3	—	—	Note 3	Note 2, 3	—	—	—
		KRP1H98A	KRP1BA101	KRP1B96	—	KRP1BA101	KRP4A98	KRP4A97	—	—	KRP1CA93	KRP4AA93	—	—	—

Note: 1. Installation box is necessary for each adaptor marked.
 2. Up to 2 adaptors can be fixed for each installation box.
 3. Only one installation box can be installed for each indoor unit.
 4. Up to 2 installation boxes can be installed for each indoor unit.
 5. Installation box is necessary for second adaptor.
 6. *1 Necessary when operating a Heat Reclaim Ventilator (VKM) independently. When operating interlocked with other air conditioners, use the remote controllers of the air conditioners.
 *2 For residential use only. When connected with a Heat Reclaim Ventilator (VKM), you can only switch the power ON/OFF, it cannot be used with other central control equipment.

Item	Type	VKM50GA(M)V1	VKM80GA(M)V1	VKM100GA(M)V1
Silencer	Nominal pipe diameter /mm	—	—	KDDM24B100
	White	K-DGL200B	—	φ 250
Air suction/ Discharge grille	Nominal pipe diameter /mm	φ 200	—	K-DGL250B
		—	—	φ 250
High efficiency filter		KAF242H80M	—	KAF242H100M
Air filter for replacement		KAF241G80M	—	KAF241G100M
Flexible duct (1 m)		K-FDS201D	—	K-FDS251D
Flexible duct (2 m)		K-FDS202D	—	K-FDS252D

Air Treatment Equipment Lineup

Heat Reclaim Ventilator – VAM series

The Heat Reclaim Ventilator creates a high-quality environment by Interlocking with the air conditioner

Model Names

VAM150GJVE, VAM250GJVE, VAM350GJVE,
VAM500GJVE, VAM650GJVE, VAM800GJVE,
VAM1000GJVE, VAM1500GJVE, VAM2000GJVE

Improved Enthalpy Efficiency¹
Higher External Static Pressure²
Enhanced Energy Saving Functions



Heat Reclaim Ventilator remote controller*
BRC301B61 (Option)

* This remote controller is used in case of independent operation of Heat Reclaim Ventilator.

This VAM series provides higher enthalpy efficiency¹, due to the greatly enhanced performance of the thin film element. Furthermore, improved external static pressure² offers more flexibility for installation. Along with these three outstanding improvements, the nighttime free cooling operation contributes to energy conservation and more comfortable environment.

¹ For models: VAM150/250/350/650/800/1000/2000GJVE

² For models: VAM150/350/500GJVE

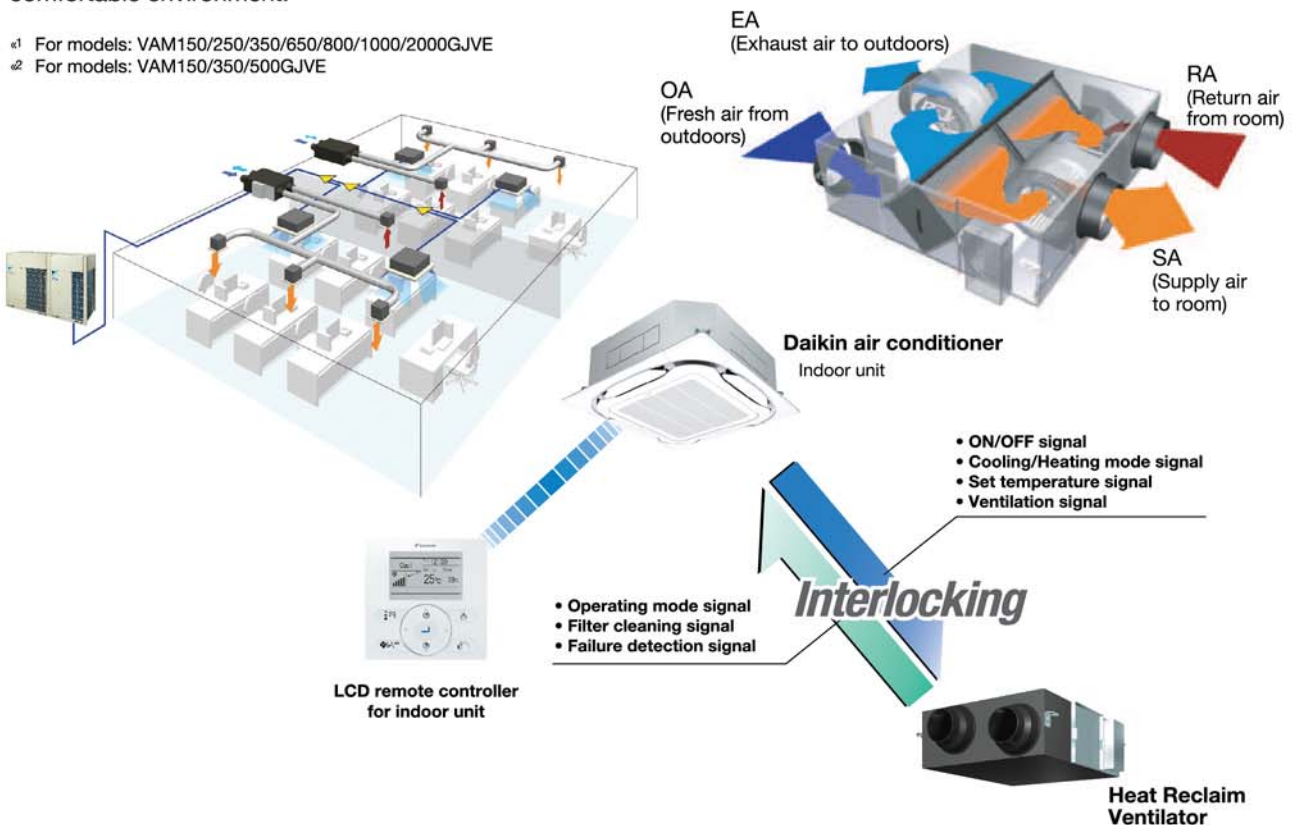

Compact Equipment

With a height of only 306 mm, the unit easily fits into limited spaces, such as above ceilings.



* For VAM500GJVE

Energy Conservation

Air conditioning load reduced by approximately 31%!

Cold Climate Compatible

Standard operation at temperatures down to -15°C.

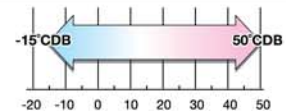

Air conditioning load reduced by approximately 31%!

Total heat exchange ventilation

This unit recovers heat energy lost through ventilation and curbs room temperature changes caused by ventilation, thereby conserving energy and reducing the load on the air conditioning system.

Enthalpy efficiency drastically improved by employing thin film element! (VAM-GJ model)

With the thinner film...

- It can decrease the moisture resistance of the partition sheets drastically.
- Gaining more space for extra layers in the element, result in increasing of effective area that supply and exhaust air can be exposed to.

Moisture absorption increased by approx. 10%!

Thickness of the partition sheet
40 μm

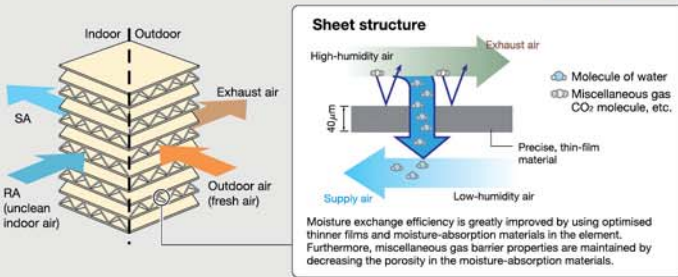

23%

Auto-ventilation Mode Changeover Switching

6%

Automatically switches the ventilation mode (Total Heat Exchange Mode/Bypass Mode) according to the operating status of the air conditioner.

+

Pre-cool, Pre-heat Control

2%

Reduces air conditioning load by not operating the Heat Reclaim Ventilator while air is still clean soon after the air conditioner is turned ON.

||

- The air conditioning load reduction values may vary according to weather and other environmental conditions at the location of the machine's installation.
- The air conditioning load reduction values are based on the following conditions; Application: Tokyo office building Building form: 6 floors above ground, 2 floors underground, floor area 2,100 m² Personnel density: 0.25 person/m² Ventilation volume: 25 m³/h Indoor air conditioning level: summer 25°C 50% RH, intermediate seasons 24°C 50% RH, winter 22°C 40% RH Operating time: 2745 hours (9 hours per day, approx. 25 days per month) Calculation method: simulation based on "MICRO-HASP/1982" of the Japan Building Mechanical and Electrical Engineers Association.

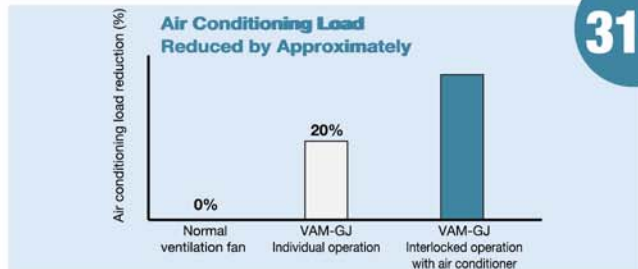

Nighttime free cooling operation^{*1}

Nighttime free cooling operation is an energy-conserving function that works at night when air conditioners are off. By ventilating rooms containing office equipment that raises the room temperature, nighttime free cooling operation reduces the cooling load when air conditioners are turned on in the morning. It also alleviates feelings of discomfort in the morning caused by heat accumulated during the night.

- Nighttime free cooling operation only works to cool and if connected to Building Multi or VRF systems.
- Nighttime free cooling operation is set to "off" in the factory settings, so if there is a need to turn on, please contact Daikin dealer.

- *1 This function can be operated only when interlocked with air conditioners.
- *2 Value is based on the following conditions:
 - Cooling operation performed from April to October.
 - Calculated for air conditioning sensible heat load only (latent heat load not included).

Air conditioning sensible heat load reduced by **approx. 5%^{*2}**!

The indoor accumulated heat is discharged at night. This reduces the air conditioning load the next day thereby increasing efficiency.

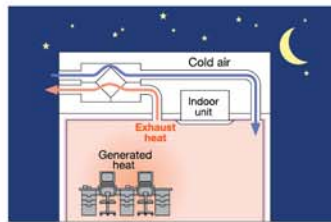

Heat is discharged.

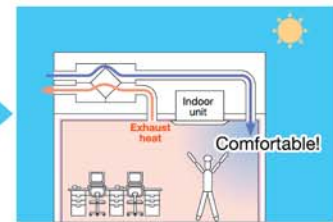

The load is small so the temperature is rapidly reduced to a comfortable level.

*Interlocked operation with an air conditioner

Air Treatment Equipment Lineup

Heat Reclaim Ventilator – VAM series

CO₂ Sensor Optional Kit Connection

The CO₂ sensor controls airflow so that it best matches the changes in CO₂ level. This prevents energy losses from over-ventilation while maintaining indoor air quality with optional CO₂ sensor.

• Example of CO₂ sensor operation in an office room:

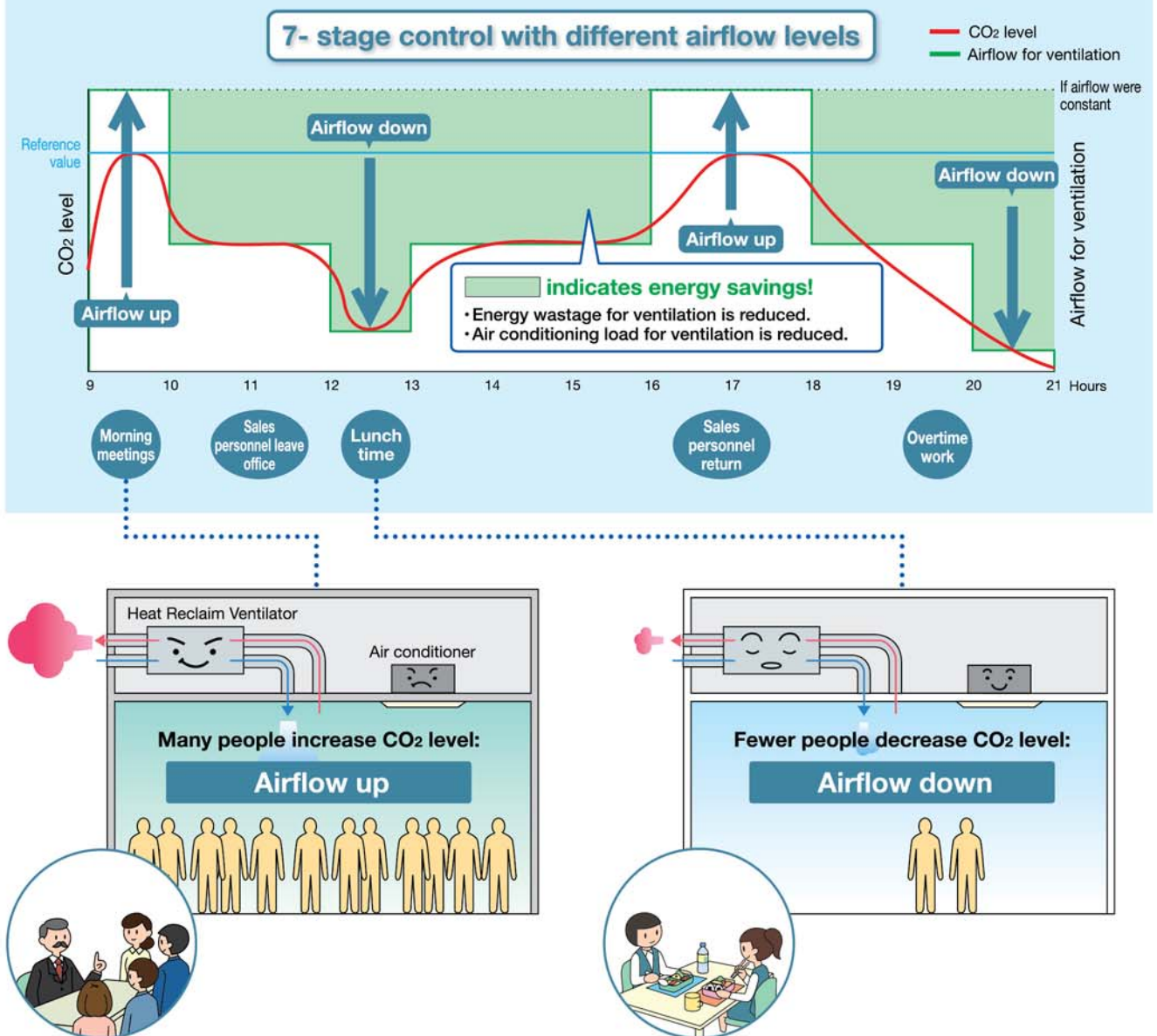

Heat Reclaim Ventilator – PM2.5 filtration unit (Option)

Rapid urbanization has increased industrial and automobile emissions, resulting in higher PM2.5 levels. This has become the source of respiratory diseases and poses a serious threat to a long term health issue. As the air quality has worsened, research has shown the harmful effects of PM2.5 on the health of the general public.

Double-layered efficient filtration

PM2.5 filters are double-layered.

1. The front filter effectively removes large particles.
2. The PM2.5 filter layer contains a large amount of static electricity to capture particulate matter efficiently.

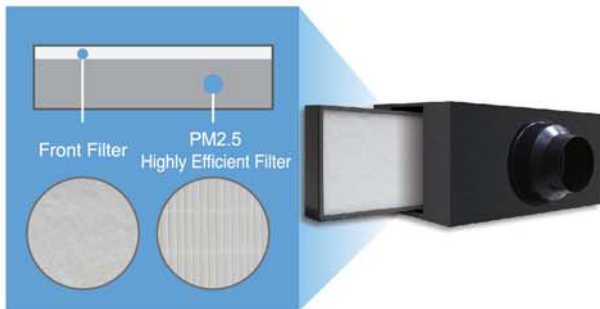

Electrostatic dust collection filter: more efficient and longer lasting effect

The PM2.5 filter layer contains a large amount of static electricity to capture particulate matter efficiently, including those smaller than the grid mesh. The filter is difficult to be blocked by particles and has good ventilation and long life span.

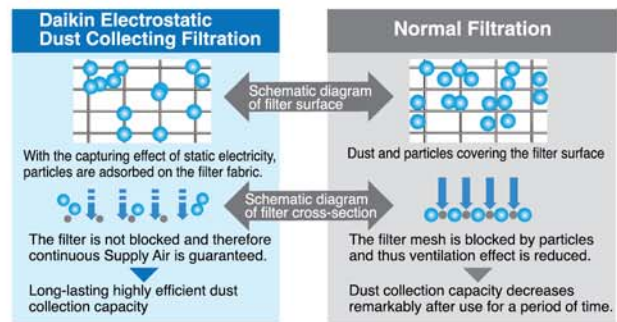

Filtering PM2.5 efficiently for healthier and more comfortable environments

The PM2.5 filtering series heat reclaim ventilator is equipped with an electrostatic dust collection filter for PM2.5 removal. This filter not only removes 99% or more of 2.5 μm ; it also eliminates up to 90% of 0.5 μm matter!

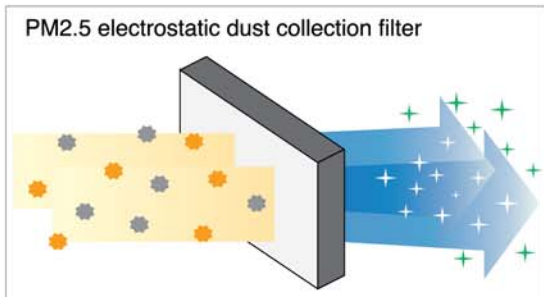

*Test results by the Heating, Ventilation and Air Conditioning Lab at Tongji University
Test environment: temperature 25-26°CDB, humidity 58-60%RH

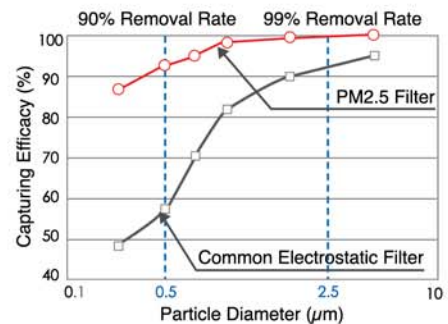

Extra-High Performance Filter Against Sulfur Oxides and Nitrogen Oxides

Effective Use of Active Carbon Material to Enlarge the Adsorption Area

As an expert in the research and development of filters, DAIKIN has specifically selected active carbon material as the main substance to constitute the filter against sulfur oxides and nitrogen oxides. The material's usable pore surface is fully exploited, thus extending the filter's durability.

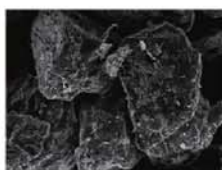

Note: Surface area of active carbon: 700 m^2/g
Given a newspaper page of 40.6 cm wide by 54.6 cm long, each gram of active carbon has a surface area of 3,000 newspaper pages.

Intelligent Identification, Super-effective Adhesion

The special substance added in the pores of active carbon can exclusively target sulfur oxide and nitrogen oxide gases and stick to them without blocking other unidentified gases. This ensures long durability of the filter.

Unidentified Gases

NO_x, SO_2

Adhesives

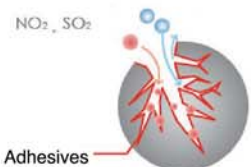

Note: The figures are based on in-house tests under the following lab conditions:
temperature 22 to 25°CDB, humidity 35 to 40% RH, air flow rate 0.2 m/s.

Air Treatment Equipment Lineup

SPECIFICATIONS

MODEL		VAM150GJVE	VAM250GJVE	VAM350GJVE	VAM500GJVE	VAM650GJVE	VAM800GJVE	VAM1000GJVE	VAM1500GJVE	VAM2000GJVE		
Power Supply		1-phase, 220-240 V/ 220 V, 50/60 Hz										
Temp. Exchange Efficiency (50/60 Hz)	Ultra-High	79/79	75/75	79/79	74/74	75/75	72/72	78/78	72/72	77/77		
	High	79/79	75/75	79/79	74/74	75/75	72/72	78/78	72/72	77/77		
	Low	84/85	79/79	82/82	80/80.5	77/77.5	74/74.5	80.5/81	75.5/76	79/81		
Enthalpy Exchange Efficiency (50/60 Hz)	Ultra-High	66/66	63/63	66/66	55/55	61/61	61/61	64/64	61/61	62/62		
	High	66/66	63/63	66/66	55/55	61/61	61/61	64/64	61/61	62/62		
	Low	70/70.5	66/66	70/70	59/59.5	64/64.5	64/64.5	68.5/69	64/64.5	66/67		
Power Consumption (50/60 Hz)	Heat Exchange Mode	Ultra-High	125/134	137/141	200/226	248/270	342/398	599/680	635/760	1,145/1,300	1,289/1,542	
		High	111/117	120/125	182/211	225/217	300/332	517/597	567/648	991/1,144	1,151/1,315	
		Low	57/58	60/59	122/120	128/136	196/207	435/483	476/512	835/927	966/1,039	
	Bypass Mode	Ultra-High	125/134	137/141	200/226	248/270	342/398	599/680	635/760	1,145/1,300	1,289/1,542	
		High	111/117	120/125	182/211	225/217	300/332	517/597	567/648	991/1,144	1,151/1,315	
		Low	57/58	60/59	122/120	128/136	196/207	435/483	476/512	835/927	966/1,039	
Sound Level (50/60 Hz)	Heat Exchange Mode	Ultra-High	27-28.5/28.5	27-29/29	31.5-33/33	33-35.5/34	34-36/36	39-40.5/39.5	39.5-41.5/39.5	39.5-41.5/41.5	41.5-43.5/42	
		High	26-27.5/27.5	26-27.5/28	30-31.5/30	31.5-34/32	33-34.5/34	37-39.5/37.5	37.5-39.5/37.5	37.5-39.5/39.5	39-43/40	
		Low	20.5-21.5/21	21-22/21	23-25/23	25-28.5/24	27.5-29.5/28	35-37.5/34	35-37.5/34.5	35-37.5/36	36-39/39	
	Bypass Mode	Ultra-High	28.5-29.5/29.5	28.5-30.5/30.5	33-34.5/34.5	34.5-36/35.5	35-37.5/37.5	40.5-42/41	40.5-42.5/40.5	41-43/42.5	43-45.5/44	
		High	27.5-28.5/28.5	27.5-29/29.5	31.5-33/31.5	33-34.5/33.5	33-35.5/35.5	38.5-40/39	38.5-40.5/38.5	39.5-41/41.5	40.5-45/42	
		Low	22.5-23.5/22	22.5-23/22.5	24.5-26.5/24.5	25.5-28.5/25.5	27.5-30.5/29.5	36-38.5/35.5	36-38.5/35.5	36.5-38/37.5	37.5-39.5/41	
Casing		Galvanised steel plate										
Insulation Material		Self-extinguishable polyurethane foam										
Dimensions (HXWXD)		mm	278X810X551		306X879X800		338X973X832	387X1,111X832	387X1,111X1,214	785X1,619X832	785X1,619X1,214	
Machine Weight		kg	24		32		45	55	67	129	157	
Heat Exchange System		Air to air cross flow total heat (Sensible heat + latent heat) exchange										
Heat Exchange Element Material		Specially processed nonflammable paper										
Air Filter		Multidirectional fibrous fleeces										
Fan	Type		Sirocco fan									
	Airflow Rate (50/60 Hz)	Ultra-High	150/150	250/250	350/350	500/500	650/650	800/800	1,000/1,000	1,500/1,500	2,000/2,000	
		High	150/150	250/250	350/350	500/500	650/650	800/800	1,000/1,000	1,500/1,500	2,000/2,000	
		Low	100/95	155/155	230/230	320/295	500/470	700/670	860/840	1,320/1,260	1,720/1,580	
	External Static Pressure (50/60 Hz)	Ultra-High	120/154	70/96	169/222	105/150	85/125	133/170	168/192	112/150	116/140	
		High	106/131	54/65	141/145	66/52	53/67	92/85	110/86	73/72	58/32	
Low		56/60	24/20	67/30	32/18	35/38	72/61	85/60	56/50	45/45		
Motor Output		kW	0.030X2		0.090X2		0.140X2	0.280X2		0.280X4		
Connection Duct Diameter		mm	φ 100	φ 150		φ 200		φ 250		φ 350		
Unit ambient condition		-15°C~50°CDB, 80%RH or less										

- Notes: 1. Sound level is measured at 1.5m below the centre of the body.
 2. Airflow rate can be changed over to Low mode or High mode.
 3. Sound level is measured in an anechoic chamber.
 Sound level generally becomes greater than this value depending on the operating conditions, reflected sound, and peripheral noise.
 4. The sound level at the air discharge port is about 8 dB(A) higher than the unit's sound level.
 5. The specifications, designs and information given here are subject to change without notice.
 6. Temperature Exchange Efficiency is the mean value between cooling and heating.
 7. Efficiency is measured under the following conditions:
 Ratio of rated external static pressure has been maintained as follows; outdoor side to indoor side = 7 to 1.
 8. In conformance with JIS standards (JIS B 8628), operating sound level is based on the value when one unit is operated, with the value converted for an anechoic chamber. This is transmission sound from the main unit, and does not include sound from the discharge grille. Thus it is normal for the sound to be louder than the indicated value when the unit is actually installed.
 9. Sound level from the discharge port causes the value to be approximately 8 dB(A) (models with the airflow rate of less than 150 to 500m³/h) to approximately 11 dB(A) (models with the airflow rate of 650m³/h or more) greater than the indicated value. Furthermore, fan rotation and noise from the discharge grille

- may increase depending on the on-site duct resistance conditions. Please consider noise countermeasures when installing the unit.
 10. With large noise models in particular (1500 and 2000m³/h models), if the supply air (SA) grille is installed near the main unit, the noise of the main unit may be heard from the discharge grille via the duct, and this will result in a marked increase in noise. In such cases, if peripheral effects are included (such as reverberation of the floor and walls, combination with other equipment, and background noise), sound level may be as much as 15 dB(A) higher than the indicated value. When installing a large model, please provide as much separation as possible between the main unit and the discharge grille. If the equipment and discharge grille are near each other, please consider countermeasures such as the following:
 • Use a sound-muffling box, flexible duct and sound-muffling air supply/discharge grilles
 • Decentralised installation of discharge grilles
 11. When installing in a location with particularly low background noise such as a classroom, please consider the following measures to avoid transmission sound from the main unit:
 • Use of ceiling materials with high sound insulating properties (high transmission loss)
 • Methods of blocking sound transmission, for example, by adding sound insulating materials around the bottom of the sound source.
 Alternatively, consider supplementary methods such as installing the equipment in a different location (corridor, etc.)

OPTIONS

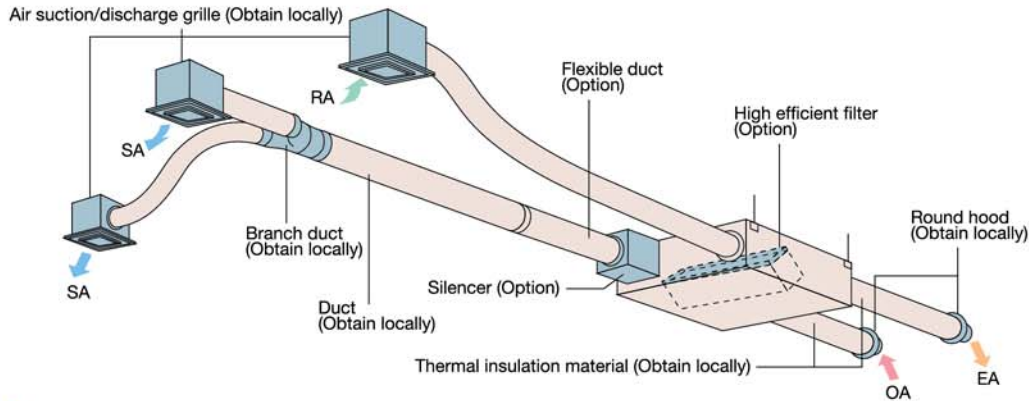

Option List

Item	Type	VAM150 · 250 · 350 · 500 · 650 · 800 · 1000 · 1500 · 2000GJVE													
Controlling device	Heat Reclaim Ventilator remote controller	BRC301B61													
	Centralised controlling device	Residential central remote controller	DCS303A51 *1												
		Central remote controller	DCS302CA61												
		Unified ON/OFF controller	DCS301BA61												
		Schedule timer	DST301BA61												
PC Board Adaptor	Wiring adaptor for electrical appendices	KRP2A61													
	For humidifier	KRP50-2													
	Installation box for adaptor PCB	KRP50-2A90 (Mounted electric component assy of Heat Reclaim Ventilator)													
	For heater control kit	BRP4A50													
	For wiring	Type (VRV indoor unit)	FXFSQ-A FXFQ-A	FXZQ-M	FXCQ-M	FXEQ-A	FXDQ-PD FXDQ-ND	FXSQ-PA	FXMQ-PA	FXMQ-MA	FXUQ-A	FXHQ-MA	FXAQ-P	FXLQ-MA FXNQ-MA	FXVQ-N
Installation box for adaptor PCB*2		KRP1C11A*	KRP1BA57*	KRP1B61*	—	KRP1B56*	KRP1C64*	KRP1C64*	KRP1B61	KRP1C67	KRP1BA54	—	KRP1B61	KRP1C67	KRP1B61
		Note 2, 3 KRP1H98A	Note 4, 5 KRP1BA101	Note 2, 3 KRP1B96	—	Note 4, 5 KRP1BA101	Note 2, 3 KRP4A98	Note 2, 3 KRP4A97	—	—	Note 3 KRP1CA93	Note 2, 3 KRP4AA93	—	—	—

- Notes: 1. Installation box*1 is necessary for each adaptor marked*1. 5. Installation box*2 is necessary for each adaptor.
 2. Up to 2 adaptors can be fixed for each installation box. 6. *1 For residential use only. When connect with a Heat Reclaim Ventilator (VAM), you can only switch the power ON/OFF. It cannot be used with other central control equipment.
 3. Only one installation box can be installed for each indoor unit.
 4. Up to 2 installation boxes can be installed for each indoor unit.

Item	Type	VAM150GJVE	VAM250GJVE	VAM350GJVE	VAM500GJVE	VAM650GJVE	VAM800GJVE	VAM1000GJVE	VAM1500GJVE	VAM2000GJVE
Additional function	Silencer	—			KDDM24B50		KDDM24B100		KDDM24B100×2	
	Nominal pipe diameter mm	—			φ 200		φ 250		φ 250	
	High efficiency filter	KAF242H25M		KAF242H50M		KAF242H65M	KAF242H80M	KAF242H100M	KAF242H80MX2	KAF242H100MX2
Air filter for replacement	KAF241H25M		KAF241H50M		KAF241H65M		KAF241H80M	KAF241H100M	KAF241H80MX2	KAF241H100MX2
Flexible duct (1 m)	K-FDS101D	K-FDS151D		K-FDS201D		K-FDS251D				
Flexible duct (2 m)	K-FDS102D	K-FDS152D		K-FDS202D		K-FDS252D				
Duct adaptor	Nominal pipe diameter mm	—							YDFA25A1 φ 250	
CO ₂ sensor		BRYMA65						BRYMA100	BRYMA65	BRYMA100
PM2.5 filtration unit		BAF249A150	BAF249A300	BAF249A350	BAF249A500		—			
PM2.5 with activated carbon filtration unit		BAF249A150C	BAF249A300C	BAF249A350C	BAF249A500C		—			

PC board adaptor for heater control kit (BRP4A50)

When the installation of an electric heater is required in a cold region, this adaptor with an internal timer function eliminates the complicated timer connecting work that was necessary with conventional heaters.

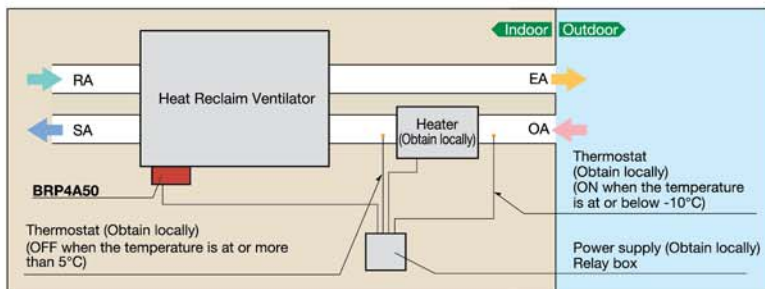

Notes when installing

- Examine fully an installation place and specification for using the electric heater based on the standard and regulation of each country.
- Supply the electric heater and safety production devices such as a relay and a thermostat, etc of which qualities satisfy the standard and regulation of each country at site.
- Use a non-inflammable connecting duct to the electric heater. Be sure to use 2 m or more between the electric heater and the Heat Reclaim Ventilator for safety.
- For the Heat Reclaim Ventilator, use a different power supply from that of the electric heater and install a circuit breaker for each.

Control Systems

Individual Control Systems for VRV Indoor Units

Navigation Remote Controller (Wired remote controller) (Option)



New BRC1E63



New BRC1F61 (Only for FXEQ series)

This simple, modern designed remote controller with fresh white colour matches your interior design. Operation is much easier and smoother, just follow the indications on the navigation remote controller.

Clear display

•Dot matrix display

• A combination of fine dots enables various icons. Large text display is easy to see.

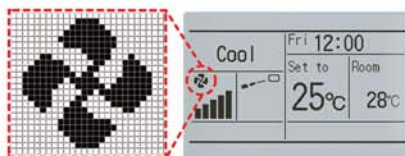

•Backlight display

• Backlight display helps operating in dark rooms.



Simple operation

•Large buttons and arrow keys

• Large buttons and arrow keys enable easy operation. Basic setting such as fan speed and temperature can be intuitively operated. For other settings, select the function from the menu list.

•Guide on display

• The display gives an explanation of each setting for easy operation.



Energy saving

•Setpoint range set

- Saves energy by limiting the min. and max. set temperature.
- Avoids excessive cooling.
- This function is convenient when the remote controller is installed at a place where any number of people may operate it.

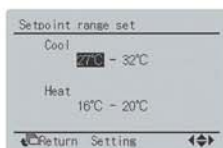

•Setpoint auto reset

- Even if the set temperature is changed, the new set temperature returns to the previous preset value after a preset duration of time.
- Period selectable from 30, 60, 90, or 120 min.

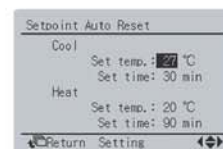

•Off timer

- Turns off the air conditioner after a preset period of time.
- Period can be preset from 30 to 180 minutes in 10-minute increments.

Restaurant sample

Restaurant opened

Temperature is set to 27°C



Full tables at lunchtime

Then is lowered to 24°C for crowded room



After 30 minutes*

Automatically returns to preset temperature (27°C) Returns to 27°C automatically



*Preset-return time can be set at 30, 60, 90, or 120 min

Convenience

•Setback (default: OFF)

Maintains the room temperature in a specific range during unoccupied period by temporarily starting air conditioner that was turned OFF.

Ex) Setback temperature **Cooling : 35°C** Recovery differential **Cooling : -2°C**
 When the room temperature goes above 35°C, the air conditioner starts operating in Cooling automatically.
 When room temperature reaches 33°C, the air conditioner returns OFF.

	Setback temperature	Recovery differential
Cooling	33 — 37°C	-2 — -8°C

•Weekly schedule

- 5 actions per day can be scheduled for each day of the week.
- The holiday function will disable schedule timer for the days that have been set as holiday.
- 3 independent schedules can be set. (e.g. summer, winter, mid-season)

Schedule nr. 1				
Time	Act	Cool	Heat	
Mon 8:30	ON	25°C	—	—
10:00	OFF	—	—	—
13:00	ON	25°C	—	—
15:00	OFF	—	—	—

Return Setting

College classroom sample (a summer Monday case)

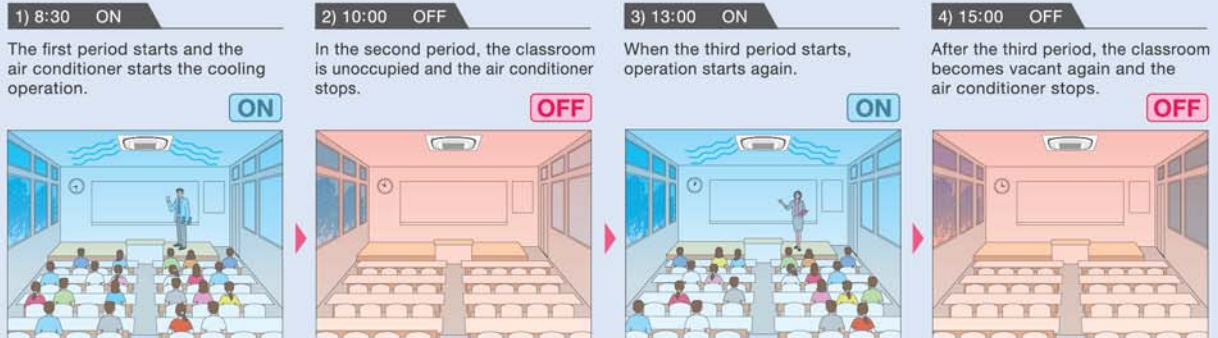

New •Auto display off

- While operation is stopping, LCD display can be turned OFF. It will be displayed again if any button is pressed.
- Period can be preset from 10, 30, 60 minutes, and OFF. Initial setting is 30 minutes.

Comfort

•Individual airflow direction (*1)

Airflow direction can be individually adjusted for each air discharge outlet to deliver optimal air distribution that conforms to conditions for airflow direction (small and large loads).

*1. Only available for FXF(S)Q-A and FXUQ-A series.

New •5-step airflow control (*2)

Control of airflow rate can be selected from 5-step control, which provides comfortable airflow.

*2. The number of airflow steps differs according to the type of indoor unit. 5-step airflow is only available for FXF(S)Q-A and FXEQ-A series.

•Auto airflow rate (*3)

Airflow rate is automatically controlled in accordance to the difference between room temperature and set temperature.

*3. Only available for FXF(S)Q-A, FXEQ-A, FXDQ-PD/ND, FXSQ-PA, FXMQ-PA and FXUQ-A series.

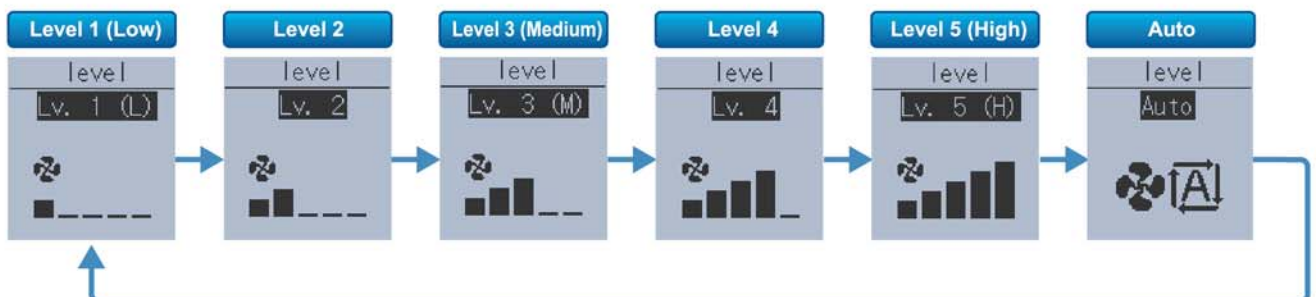

Individual Control Systems for VRV Indoor Units



BRC1C62

- Displays current airflow, swing, temperature, operating mode and timer settings.

* Individual airflow direction, auto airflow rate and sensing sensor control can be set only via wired remote controller BRC1E63. Cannot be set via other remote controllers.

The wired remote controller supports a wide range of control functions

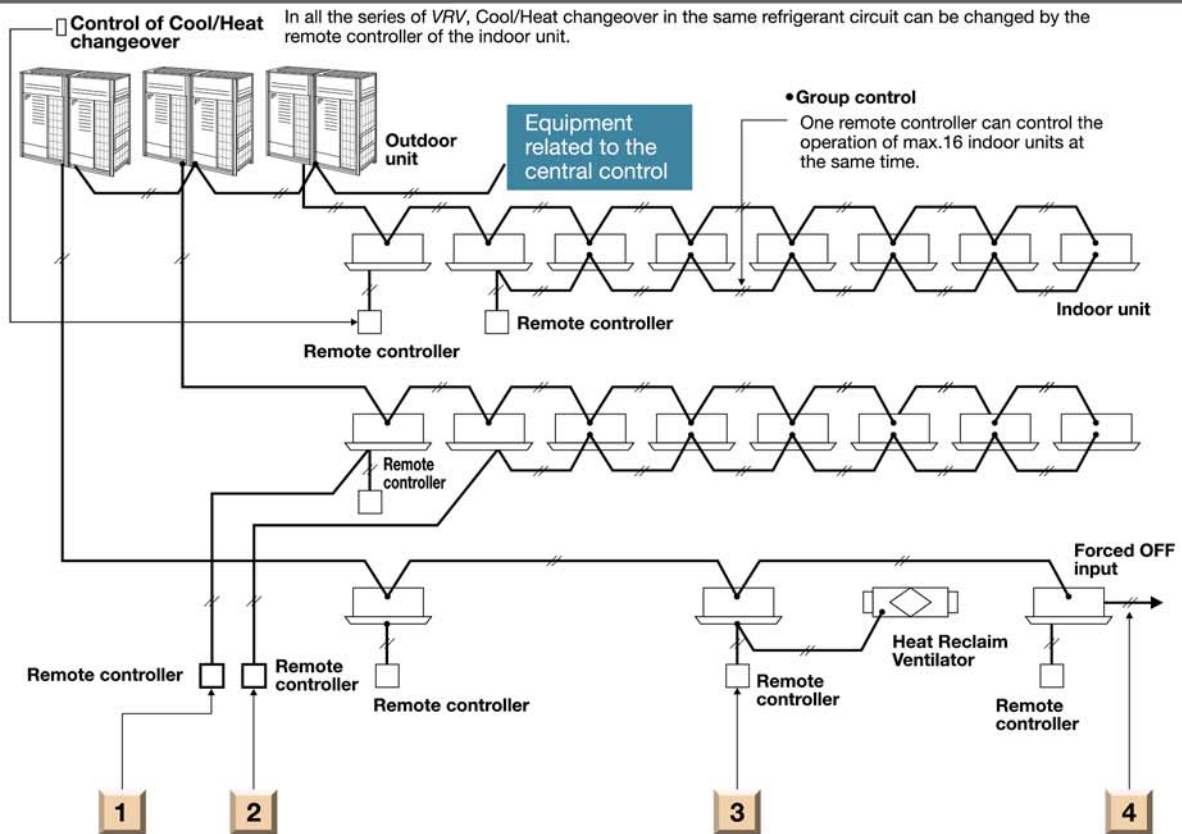

1 Control by two remote controller

The indoor unit can be connected by the two remote controller, for example one in the room and the other one in the control room, which can control the operation of indoor unit freely. (The last command has a priority.) Of course, the group control by two remote controller is also possible.

2 Remote control

The wiring of remote controller can be extended to max. 500 m and it is possible to install the remote controllers for different indoor units in one place.

3 Control for the combined operation

The operation of Heat Reclaim Ventilator can be controlled by the remote controller of the indoor unit. Of course, the remote controller can display the time to clean the filter.

4 Expansion of system control

The system can be expanded to add several controllers, such as BMS, Forced OFF input and etc.

Wireless remote controller (Option)



Signal receiver unit
(Installed type)

New BRC7M635F
(For FXF(S)Q series)

- The wireless remote controller is supplied in a set with a signal receiver.
- Signal receiver unit of installed type is contained inside decoration panel or indoor unit.
- Shape of signal receiver unit differs according to the indoor unit.

Note: The signal receiver unit shown in the photograph is for mounting inside the decoration panel of FXF(S)Q series.

- New** • Backlight LCD of new wireless remote controller



Pressing the backlight button helps operating in dark rooms.



Wireless remote controller



Signal receiver unit
(Separate type)

- A compact signal receiver unit (separate type) to be mounted into a wall or ceiling is included.

* Wireless remote controller and signal receiver unit are sold as a set.
* Refer to page 91 for the name of each model.

Simplified remote controller (Option)



Exposed type
(BRC2C51)



Concealed type
(For hotel use)
(BRC3A61)

- The remote controller has centralised its frequently used operation selectors and switches (on/off, operation mode, temperature setting and airflow volume), making itself suitable for use in hotel rooms or conference rooms.
- The exposed type remote controller is fitted with a thermostat sensor.



The concealed type remote controller smartly fits into a night table or console panel in a hotel room.

Wide variation of remote controllers for VRV indoor units

	FXF(S)Q	FXZQ	FXCQ	FXEQ	FXDQ	FXSQ	FXMQ	FXUQ	FXHQ	FXAQ	FXL(N)Q	FXVQ	FXB(P)Q
Navigation remote controller (Wired remote controller) (BRC1E63)	●	●	●		●	●	●	●	●	●	●	●	●
Navigation remote controller (Wired remote controller) (BRC1F61)				●									
Wired remote controller (BRC1C62)		●	●		●	●	●	●	●	●	●	●	●
Wireless remote controller* (Installed type signal receiver unit)	●	●	●	●				●	●	●			
Wireless remote controller* (Separate type signal receiver unit)					●	●	●				●		●
Simplified remote controller (Exposed type) (BRC2C51)					●	●	●				●		●
Simplified remote controller (Concealed type: for Hotel use) (BRC3A61)					●	●	●				●		●

*Refer to page 91 for the name of each model.

Control Systems

■ Integrated Building Monitoring System

The high speed transmission of DIII-NET enables more advanced control of the **VRV** system, providing you with enhanced comfort.

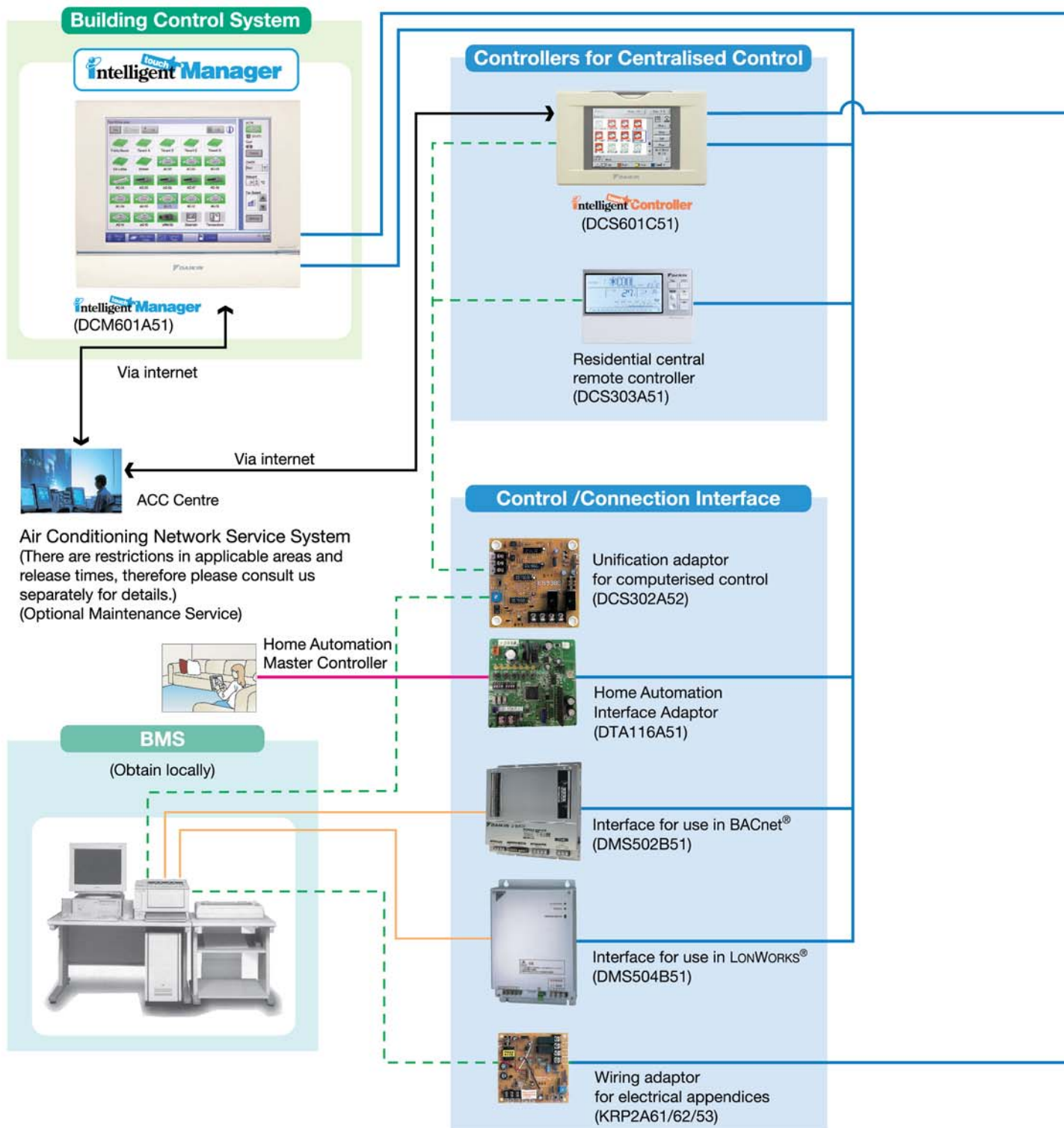

- DIII-NET Line
- BACnet®/Ethernet or LONWORKS® Network Communication Line
- - - Contact Signal Line
- RS485 Modbus Line

The DIII-NET system provides for:

- Close control and monitoring by integrating a wide variety of air-conditioners in the entire building.
- Saves the in-building cabling using non-polar, two-wire cables. Easier wiring work with tremendously fewer wiring errors.
- Additional setups readily up and running. An extendable cabling up to 2 km in total.
- Different control equipment flexibly joined in the system for hierarchical risk diversification.
- Daikin's total heat exchangers and other devices under integral control.

DIII-NET

(High Speed Multiple Transmission)

DIII-NET, Daikin's unique high speed multiple transmission system, links air conditioners and various other building equipment—in accordance with applications, scale and conditions—and transmits vast amounts of information between them.

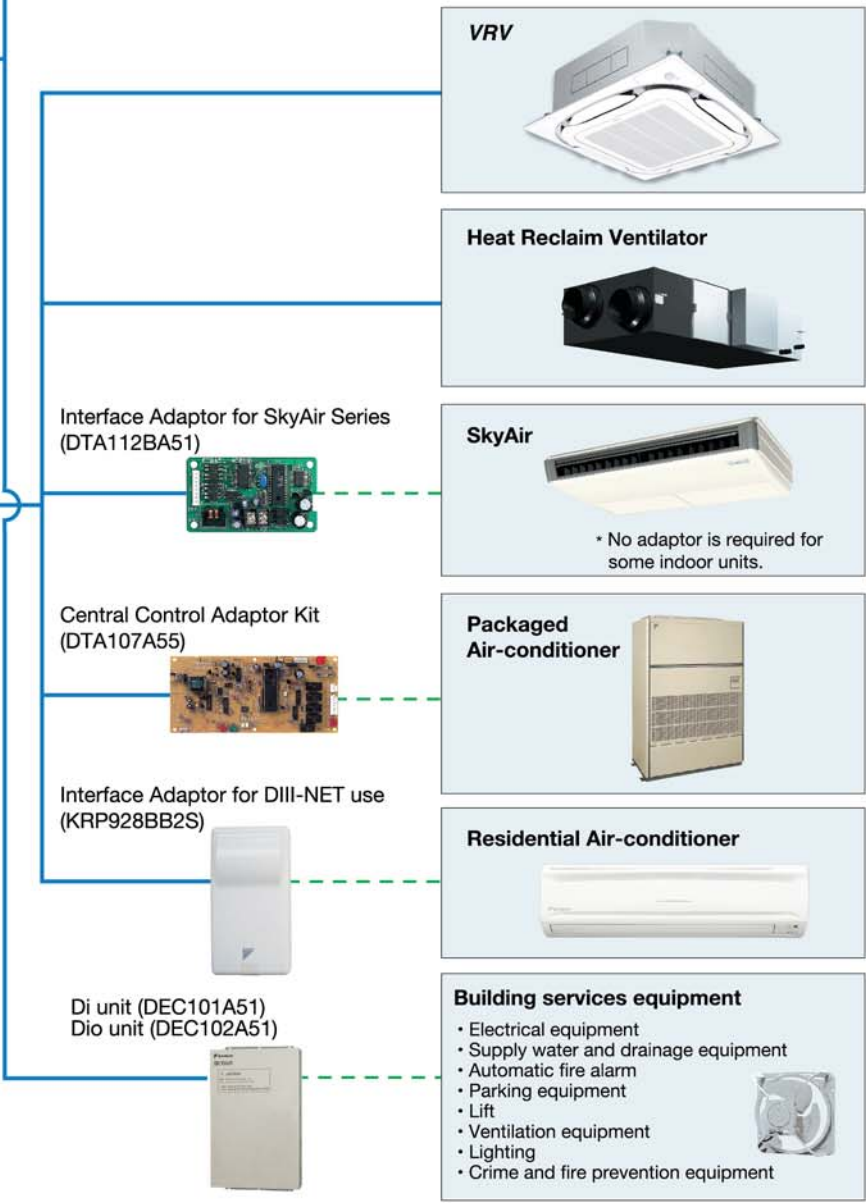

Caution:
Limitation may apply to some models and functions. Please contact your local sales office for details. Consultation is necessary before employing this control system. Please contact your local sales office before making a purchase.

Note: BACnet® is a registered trademark of American Society of Heating, Refrigerating and Air-Conditioning Engineers (ASHRAE). LONWORKS® is a trademark of Echelon Corporation registered in the United States and other countries.

Control Systems

Advanced Control Systems for VRF Indoor Units



One touch selection enables flexible control of equipment in a building.



DCM601A51

Various types of equipment in a building can be controlled by a single controller.

Individual air-conditioning control

The flexible control achieved by the **VRF** system precisely meets different air conditioning needs in each room (e.g. offices, conference rooms, hotel rooms).



Lighting control

DALI-compatible

DALI-compatible LED lighting systems can be controlled and monitored. Lighting control is enhanced through an interlock function with air conditioners and other functions.



Air-conditioning control for large spaces

Air handling units can also be controlled. Large spaces, such as entrance halls and shopping malls, can be easily controlled to ensure comfort.

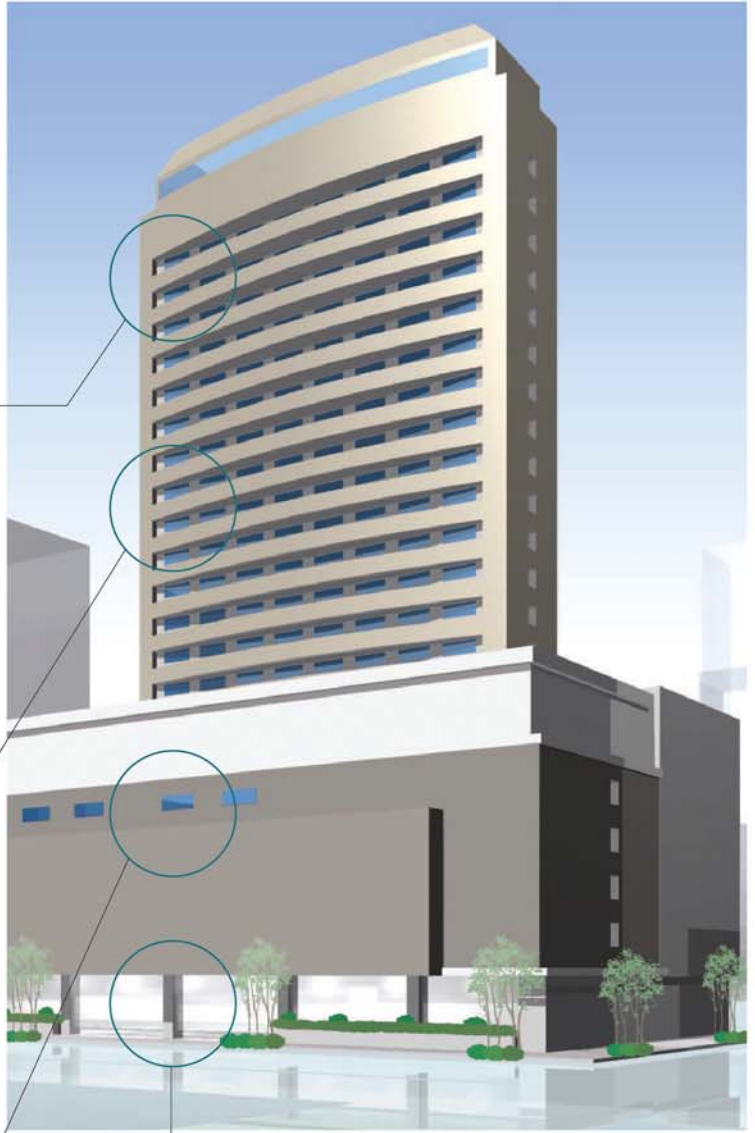

Building equipment control

Various types of equipment other than air conditioners, including ventilators, fans, and pumps, can also be controlled.



Pump



Fan

For Energy Saving & Comfort



intelligent Touch Manager maximises the advantages of VRV features

intelligent Touch Manager is an advanced multi-zone controller that provides the most cost-effective way to control and monitor the Daikin VRV system.

The 10.4" LCD touch screen is easy to use with three different screen views to include the floor plan layout view, icon view and list view and menus for system configurations.

It is also easy to use with standardized remote Web Access from your PC.

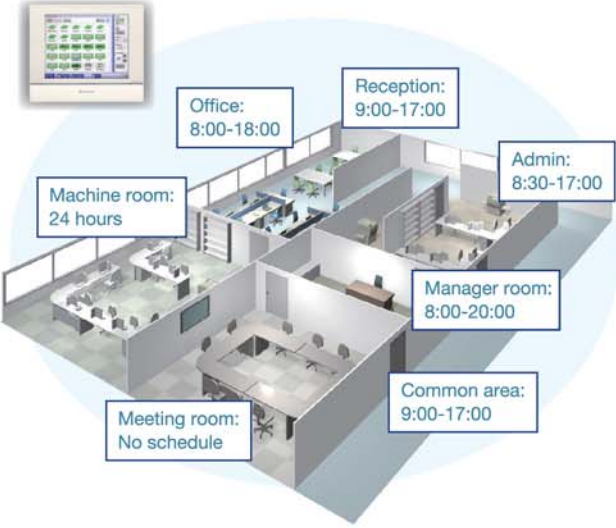
It can manage a total of 650 management points consisting of up to 512 Daikin indoor unit groups (up to 1024 indoor units) along with building equipment control / monitoring with Digital Inputs / Output (Di/Dio), Analog Inputs / Output (Ai/Ao) and Pulse input (Pi) optional devices.

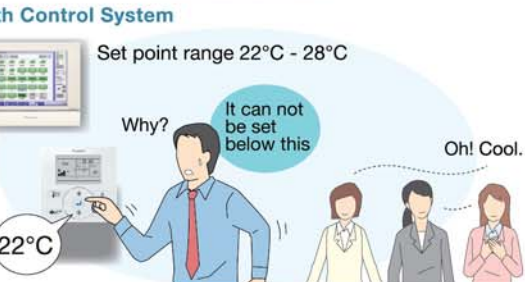
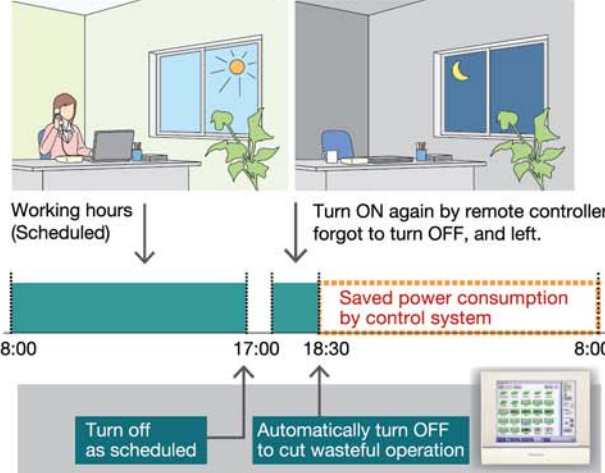
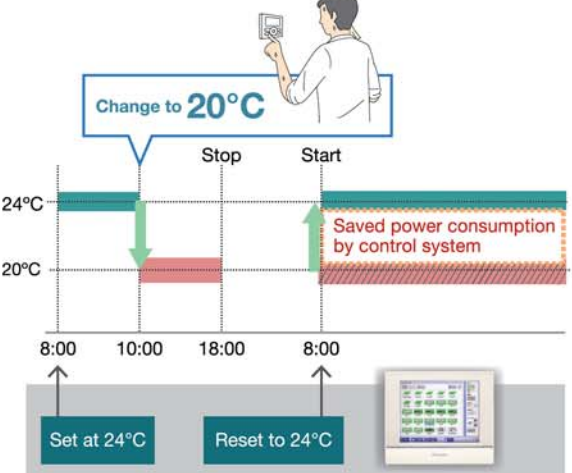
<p>Schedule the operation time for each application.</p> 	<p>Define the setpoint range that users can change.</p> <p>With Remote controller</p>  <p>With Control System</p> 
<p>Turn the unit OFF if a user didn't.</p> 	<p>Reset setpoint regularly.</p> 

Control Systems

Advanced Control Systems for VRV Indoor Units

In addition to switching lights on and off, advanced lighting control, such as illuminance adjustment, can be achieved

Lighting control (Option)

Connection to DALI - compatible lighting control system

Simple wiring (daisy chain) enables management of LED lighting by the *intelligent Touch Manager*.

Various air conditioning and lighting control is enabled through the interlock with occupancy sensors and illuminance sensors.

DALI-compatible

Please contact your local sales office for details.

Lighting control achieved by the *intelligent Touch Manager*

[Operation]

- Switch-on/switch-off operation
- Illuminance (1–100%) control
- Various illuminance patterns can be registered
- Registered pattern can be selected from *intelligent Touch Manager*

[Monitoring]

- Switch-on/switch-off status monitoring
- Lighting abnormality monitoring
- Illuminance monitoring
- DALI occupancy sensor monitoring
- DALI illuminance sensor monitoring

Air conditioning and lighting for which power consumption is high can be efficiently controlled to promote energy conservation and cost reduction!

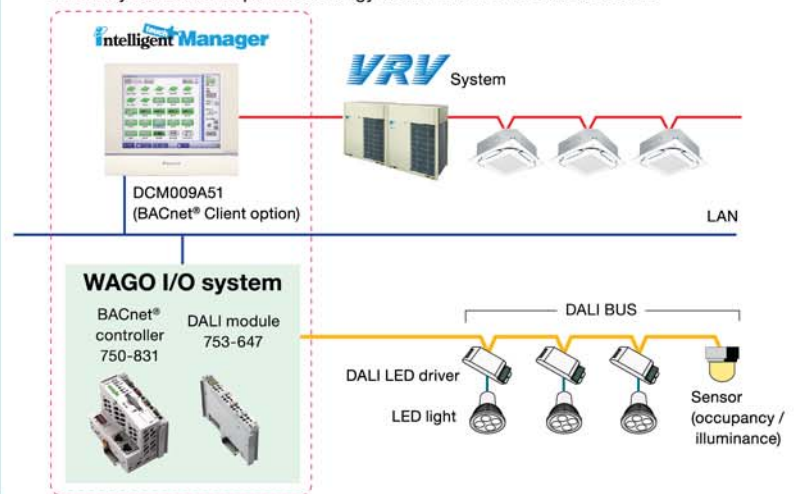

[Overview of control]

- Up to 5 DALI modules can be connected to a single BACnet® controller.
- Up to 64 DALI LED drivers (64 addresses) can be connected to a single DALI module.
- 64 DALI addresses can be freely assigned to up to 16 groups using a single DALI module. (Each group corresponds to a management point of the *intelligent Touch Manager*.)
- Up to 16 scenes can be set to a single DALI module.
- Up to 12 sensors (occupancy, illuminance) can be connected to a single DALI module.
- DALI BAS simplifies wiring and setting work by daisy chain wiring and automatic address setting.

Easy maintenance and energy saving by lighting control

Case1

Switch-on / switch-off and illuminance are controlled based on a schedule to cut wasteful power consumption.

- Failing to switch off lights is prevented.



- Optimal illuminance reduces energy.

Case2

Occupancy sensors are used to eliminate both wasteful lighting and air conditioning.

When a room is unoccupied, the air conditioning stops and the lighting is switched off.

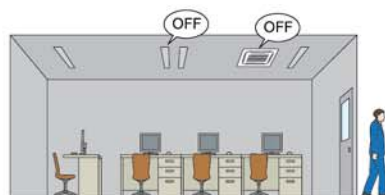

Case3

Lighting abnormalities (e.g. burned-out bulbs) can be checked on the *intelligent Touch Manager* screen.

Lighting maintenance becomes easier and quicker.

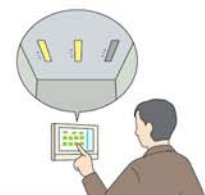

The layout screen enables quick identification of specific locations.

Tenant Management (PPD* Option)

Reporting the power consumption of VRF system for each tenant

With the PPD function, power consumption can be calculated for each indoor unit (Option)

The energy consumption is proportionally calculated for each indoor unit. The data can be used for energy management and calculation of air conditioning usage fees for respective tenants.

Operational information of individual indoor units are monitored, based on distribution of power consumption of outdoor units.

Daikin's PPD keeps track of power distribution for each indoor unit. It performs air conditioning billing calculations quickly and automatically.

It is easy to output PPD data.

PPD data is output in CSV format to a PC or USB memory device and can be freely processed and managed.

*PPD (Power Proportional Distribution) is Daikin's proprietary calculation method.

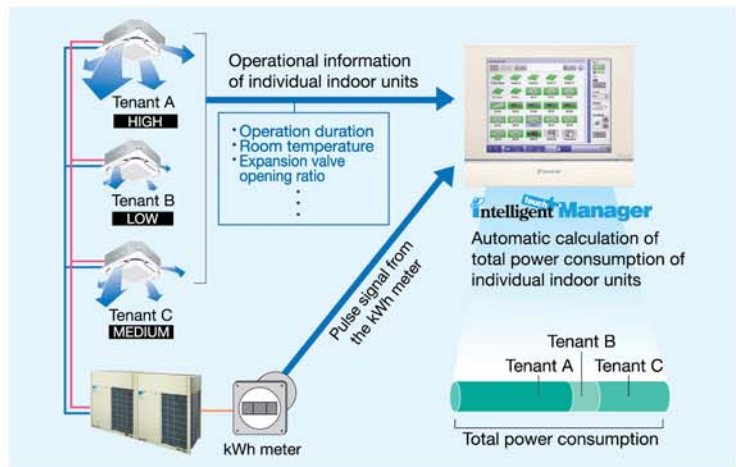

Air conditioning bills can be issued by one click

Electricity bills can be easily calculated for each tenant (Option)

The power consumption of VRF controlled by the *intelligent Touch Manager* can be easily managed for each tenant using a PC. The electricity bill settings facilitate billing work through easy calculation and issuance of VRF electricity bills.

[Main functions]

- Register tenants
- Set the electricity unit price for 5 time zones
- Calculate power consumption and electricity charge for each tenant
- Show aggregation results in the specified period for each tenant
- Output the results (Printout and CSV file)

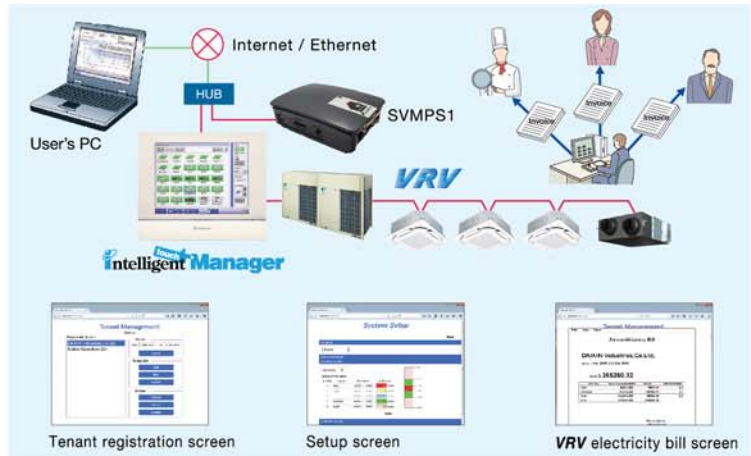

Effective service functions offered to tenants

Smart phone will be a remote controller of VRF system (Option)

Users can operate and check the status of VRF system from their smart phones via Wi-Fi. It is not necessary to move where a remote controller is located with this feature.

VRF system in other rooms can be operated, and their status can be checked.

It is also possible to check if air conditioners in other rooms remain switched on etc., helping achieve energy saving.

For buildings VRF Smart Phone Remote Controller



Control Systems

Advanced Control Systems for VRF Indoor Units

System structure

intelligent Touch Manager System Overview

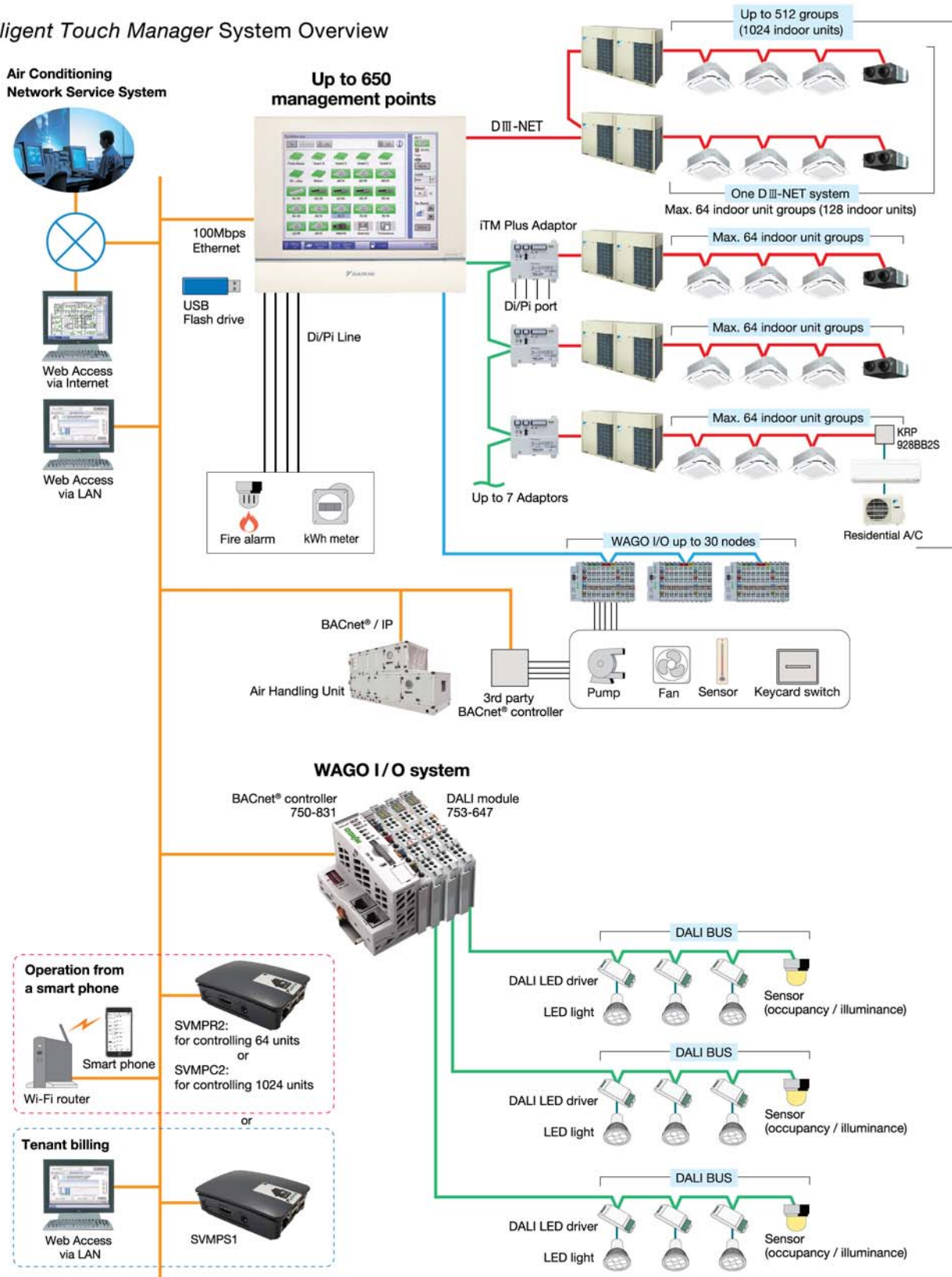

Air Conditioning Network Service System

Preventive Maintenance

The *intelligent Touch Manager* can be connected to Daikin's own Air Conditioning Network Service System for remote monitoring and verification of operation status for **VRV** system. By its ability to predict malfunctions, this service provides customers with additional peace of mind.

Enhanced convenience with link to the Air Conditioning Network Service System

The *intelligent Touch Manager* connects seamlessly to Daikin's 24-hour Air Conditioning Network Service System.

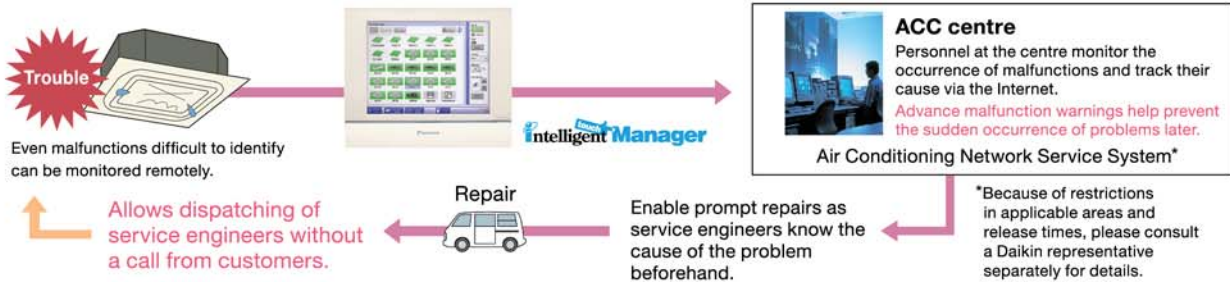

Daikin Offers a Variety of Control Systems

Convenient controllers that offer more freedom to administrators



DCS601C51

Intelligent Controller

Ease of use and expanded control functions

The user-friendly controller features colours, multilingual function, and icons in the display for ease of understanding. A wide variety of control methods can be accommodated, permitting administrators to monitor and operate the system even when they are away from the controller.

Connect VRV system to your BMS via BACnet® or LONWORKS®

Compatible with BACnet® and LONWORKS®, the two leading open network communication protocols, Daikin offers interfaces that provide a seamless connection between **VRV** system and your BMS.

Dedicated interfaces make Daikin air conditioners freely compatible with open networks



DMS502B51
(Interface for use in BACnet®)

BACnet®
Seamless connection between **VRV** system and BACnet® open network protocol.



DMS504B51
(Interface for use in LONWORKS®)

LONWORKS®
Facilitating the network integration of **VRV** system and LONWORKS®

Notes: 1. BACnet® is a registered trademark of American Society of Heating, Refrigerating and Air-Conditioning Engineers (ASHRAE).

2. LONWORKS® is a trademark of Echelon Corporation registered in the United States and other countries.

Smart phone will be a remote controller of VRV system (Option)

For house VRV Smart Phone Control System

Up to 64 indoor units can be controlled.

Just add SVMPR2 to this system

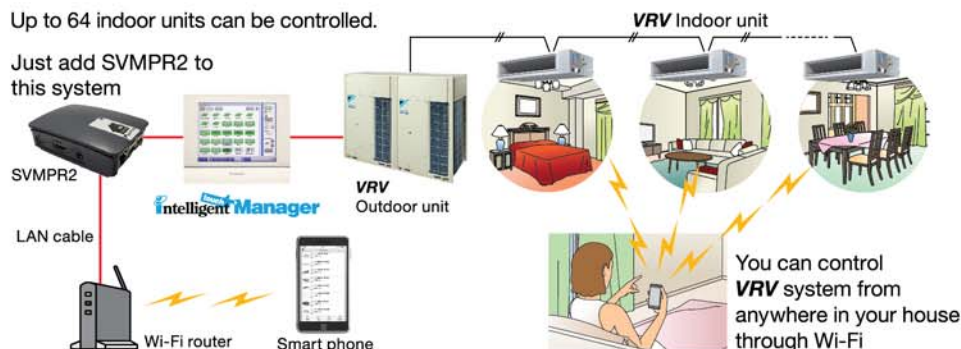

Monitor



Control

Control Systems

Advanced Control Systems for VRV Indoor Units

Home Automation Interface Adaptor

The VRV system can be operated from the home automation system.

Image to use Home Automation Interface Adaptor DTA116A51

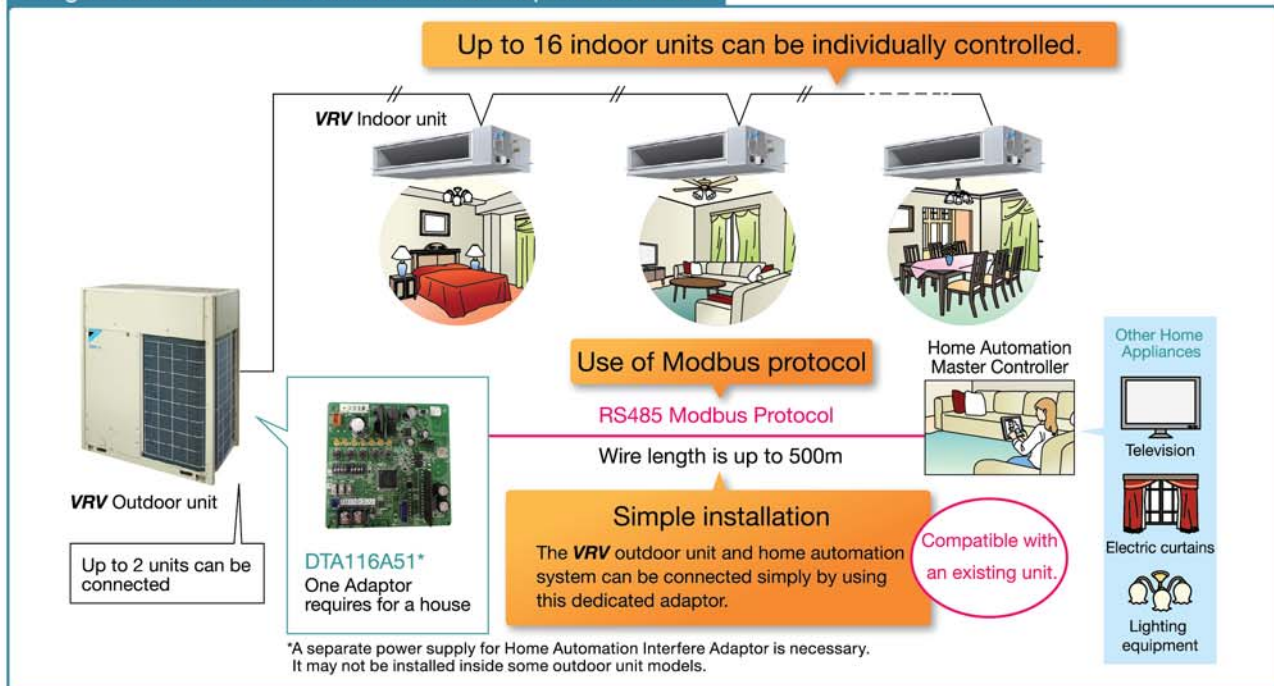

Functions

Monitor

On/Off	On/Off status of indoor units
Operation mode	Cooling, Heating, Fan, Dry, Auto (depend on indoor unit capability)
Setpoint	Setpoint of indoor units
Room temperature	Suction temperature of indoor units
Fan direction	Swing, Flap direction (depend on indoor unit capability)
Fan volume	L, M, H (depend on indoor unit capability)
Forced off status	Forced off status of indoor units
Error	Malfunction, Warning with Error code
Filter sign	Filter sign of indoor units
Communication status	Communication normal/error of indoor units

Control

On/Off	On/Off control of indoor units
Operation mode	Cooling, Heating, Fan, Dry, Auto (depend on indoor unit capability)
Setpoint	Cooling/Heating setpoint
Fan direction	Swing, Stop, Flap direction (depend on indoor unit capability)
Fan volume	L, M, H (depend on indoor unit capability)
Filter sign reset	Reset filter sign of indoor units

Retrieve system information

Connected indoor units	DIII-NET address of connected indoor units can be retrieved.
Indoor unit capabilities	Indoor unit capabilities such as operation mode, fan control, setpoint HV can be retrieved.

VRV Smart Phone Control System

VRV Smart Phone Control System can be realized by SVMPR1 which is a new product to utilize DTA116A51.



★Modbus is a registered trademark of Schneider Electric S.A.

VRV Tablet Controller : SVMPC1

The SVMPC1 is easy to install, and enables monitoring and operation of VRV systems via tablets and smartphones. It is optimal for centralized management of VRV systems in small buildings or on individual floors of a building.

Simple and easy Smart Control

- SVMPC1 is easy to install. Just add DTA116A51 to outdoor unit and connect it to controller.
- Thanks to user-friendly screen, anyone can operate easily.



- SVMPC1 allows operation of VRV system from anywhere (inside and outside of a premise) through the internet.
- Set point range limitation and setback function achieve energy saving and comfortable air-conditioning.
- Daily air-conditioning operation is automatically done by schedule function with annual calendar.
- Quick notification of malfunction by e-mail to support quick maintenance.

Up to 32 indoor units can be monitored and controlled.

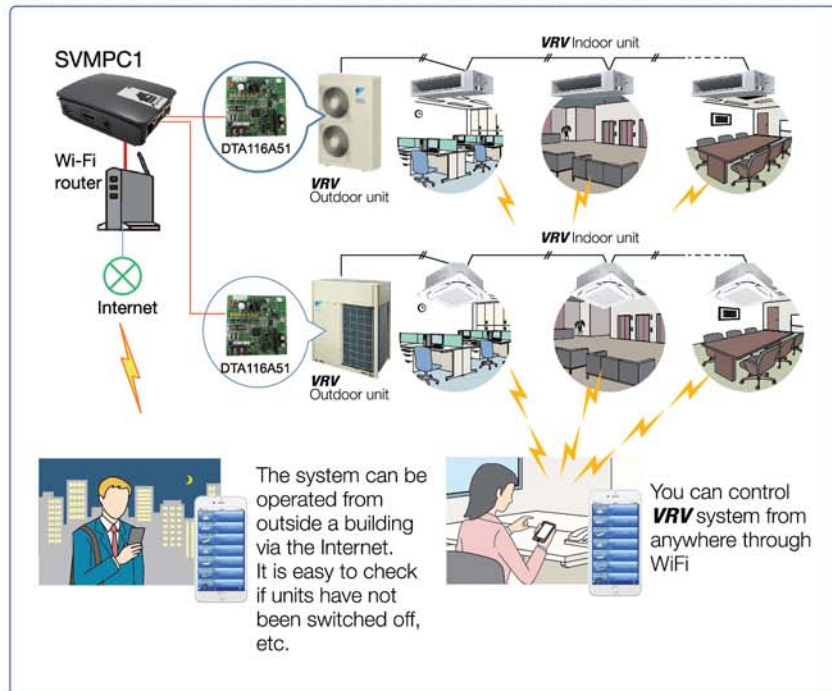

■ Functions

*: only admin user can set

Category	Function	Detail
Access security	User login	User name, password
	Device registration	Registered device (Tablet, Smartphone) can access through the internet
Main screen	Status monitoring	On/Off, Setpoint, Operation mode, Fan step, Flap, Error, Error code, Room Temperature
	Manual operation	On/Off, Setpoint, Operation mode, Fan step, Flap
Automatic control	Setpoint range limitation*	Cool setpoint min/max, Heat setpoint min/max
	Off timer*	Off timer on/off, Off timer duration (5min – 12h, every 5min)
	Setback operation*	Setback setpoint range (Cool: 24-35°C, Heat: 10-20°C)
	Schedule*	Action registration: Time, On/Off, Setpoint, Operation mode, Fan step, Flap, Off timer on/off, Setback setpoint Calendar setting: set by date or day of the week
System setting	Language	English, Spanish, Portuguese, Thai, Vietnam, Simplified Chinese, Traditional Chinese
	Password setting	
	User administration*	Add/Modify/Delete user, Set User name, Password, Accessible points
	Point setting*	Set point name, Select icon

■ Specifications

Category	Specification	Detail
Connectable units	Number of indoor units	Max 32 (with additional DTA116A51)
	Number of DTA116A51	Max 2
Connectable device	Number of Tablet/Smartphone	Max 20
	Device type	iPad, iPhone, Android tablet, Android Phone, Windows Tablet, Windows Phone, Windows PC, Mac
	Web browser	Firefox, Chrome, Safari

Option List

Outdoor Units

VRV A SERIES

No.	Type		RXQ6AY1S RXQ8AY1S RXQ10AY1S	RXQ12AY1S RXQ14AY1S RXQ16AY1S	RXQ18AY1S RXQ20AY1S	RXQ18AMYS RXQ20AMYS RXQ22AMYS
	Item					
1	Distributive piping	REFNET header	KHRP26M22H, KHRP26M33H (Max. 4 branch) (Max. 8 branch)			
		REFNET joint	KHRP26A22T, KHRP26A33T			
2	Outdoor unit multi connection piping kit		-			BHFP22P100

No.	Type		RXQ24AMYS RXQ26AMYS RXQ28AMYS RXQ30AMYS RXQ32AMYS	RXQ34AMYS RXQ36AMYS RXQ38AMYS RXQ40AMYS	RXQ42AMYS RXQ44AMYS RXQ46AMYS RXQ48AMYS RXQ50AMYS	RXQ52AMYS RXQ54AMYS RXQ56AMYS RXQ58AMYS RXQ60AMYS
	Item					
1	Distributive piping	REFNET header	KHRP26M22H, KHRP26M33H, KHRP26M72H, KHRP26M73H (Max. 4 branch) (Max. 8 branch) (Max. 8 branch)			
		REFNET joint	KHRP26A22T, KHRP26A33T, KHRP26A72T, KHRP26A73T			
2	Pipe size reducer		KHRP26M73TP, KHRP26M73HP			
3	Outdoor unit multi connection piping kit		BHFP22P100		BHFP22P151	

REFNET joint (KHRP26A22/33/72/73T)



Option PCB

No.	Type		RXQ6AY1S RXQ8AY1S RXQ10AY1S RXQ12AY1S	RXQ14AY1S RXQ16AY1S RXQ18AY1S RXQ20AY1S	RXQ18AMY1S RXQ20AMY1S RXQ22AMY1S RXQ24AMY1S	RXQ26AMY1S RXQ28AMY1S RXQ30AMY1S
	Item					
1	DIII-NET expander adaptor ★		DTA109A51			
2	External control adaptor ★		DTA109A61			
3	Home Automation Interface Adaptor ★		DTA116A51			
4	Option plate for control adaptor		-	BKS26A *1	-	

No.	Type		RXQ32AMYS RXQ34AMYS RXQ36AMYS RXQ38AMYS RXQ40AMYS	RXQ42AMYS RXQ44AMYS	RXQ46AMYS RXQ48AMYS RXQ50AMYS RXQ52AMYS	RXQ54AMYS RXQ56AMYS RXQ58AMYS RXQ60AMYS
	Item					
1	DIII-NET expander adaptor ★		DTA109A51			
2	External control adaptor ★		DTA109A61			
3	Home Automation Interface Adaptor ★		DTA116A51			
4	Option plate for control adaptor		BKS26A *1	-	BKS26A *1	

Note: 1. This plate is necessary for each adaptor marked ★.

VRV Indoor Units

Ceiling Mounted Cassette (Round Flow with Sensing) Type

No.	Item		Type	FXFSQ25A FXFSQ32A FXFSQ40A	FXFSQ50A FXFSQ63A FXFSQ80A	FXFSQ100A FXFSQ125A FXFSQ140A
1	Decoration panel	Standard panel with sensing	Fresh white		BYCQ125EEF	
			Black		BYCQ125EEK	
		Standard panel	Fresh white		BYCQ125EAF *	
			Black		BYCQ125EAK *	
		Designer panel ¹	Fresh white		BYCQ125EAPF *	
Auto grille panel ^{2,3}	Fresh white		BYCQ125EASF *			
2	Sealing material of air discharge outlet ⁴	For usage of 3-, 4-way flow			KDBH551C160	
		For usage of 2-way flow			KDBH552C160	
3	Panel spacer				KDBP55H160FA	
4	Fresh air intake kit	Chamber type ^{5,6}	Without T-duct joint	KDDP55B160 (Components: KDDP55C160-1, KDDP55B160-2) ⁸		
			With T-duct joint	KDDP55B160K (Components: KDDP55C160-1, KDDP55B160K2) ⁸		
		Direct installation type ⁷		KDDP55X160A		
5	High-efficiency filter unit ⁹ (Including filter chamber)	(Colorimetric method 65%)		KAFP556C80		KAFP556C160
		(Colorimetric method 90%)		KAFP557C80		KAFP557C160
6	Replacement high-efficiency filter ^{9,10}	(Colorimetric method 65%)		KAFP552B80		KAFP552B160
		(Colorimetric method 90%)		KAFP553B80		KAFP553B160
7	Filter chamber			KDDFP55C160		
8	Replacement long-life filter			KAFP551K160		
9	Replacement long-life filter (Auto grille panel)			KAFP551H160		
10	Ultra long-life filter unit (Including filter chamber) ⁹			KAFP55C160		
11	Replacement ultra long-life filter ^{9,10}			KAFP55H160H		
12	Branch duct chamber ⁴			KDJP55C80		KDJP55C160
13	Insulation kit for high humidity ^{9,11}			KDTP55K80		KDTP55K160

Ceiling Mounted Cassette (Round Flow) Type

No.	Item		Type	FXFQ25A FXFQ32A FXFQ40A	FXFQ50A FXFQ63A FXFQ80A	FXFQ100A FXFQ125A FXFQ140A
1	Decoration panel	Standard panel	Fresh white		BYCQ125EAF *	
			Black		BYCQ125EAK *	
		Designer panel ¹	Fresh white		BYCQ125EAPF *	
		Auto grille panel ^{2,3}	Fresh white		BYCQ125EASF *	
2	Sealing material of air discharge outlet ⁴	For usage of 3-, 4-way flow			KDBH551C160	
		For usage of 2-way flow			KDBH552C160	
3	Panel spacer				KDBP55H160FA	
4	Fresh air intake kit	Chamber type ^{5,6}	Without T-duct joint	KDDP55B160 (Components: KDDP55C160-1, KDDP55B160-2) ⁸		
			With T-duct joint	KDDP55B160K (Components: KDDP55C160-1, KDDP55B160K2) ⁸		
		Direct installation type ⁷		KDDP55X160A		
5	High-efficiency filter unit ⁹ (Including filter chamber)	(Colorimetric method 65%)		KAFP556C80		KAFP556C160
		(Colorimetric method 90%)		KAFP557C80		KAFP557C160
6	Replacement high-efficiency filter ^{9,10}	(Colorimetric method 65%)		KAFP552B80		KAFP552B160
		(Colorimetric method 90%)		KAFP553B80		KAFP553B160
7	Filter chamber			KDDFP55C160		
8	Replacement long-life filter			KAFP551K160		
9	Replacement long-life filter (Auto grille panel)			KAFP551H160		
10	Ultra long-life filter unit (Including filter chamber) ⁹			KAFP55C160		
11	Replacement ultra long-life filter ^{9,10}			KAFP55H160H		
12	Branch duct chamber ⁴			KDJP55C80		KDJP55C160
13	Insulation kit for high humidity ^{9,11}			KDTP55K80		KDTP55K160

Note: 1. When installing designer panel, body height (ceiling required dimension) is 42 mm higher than standard panel. Designer panel cannot operate 2 and 3 way flow.
 2. A dedicated wireless remote controller (BRC16A2) for the auto grille panel is included for lowering and raising the suction grille.
 3. When installing auto grille panel, body height (ceiling required dimension) is 55 mm higher than standard panel.
 4. Circulation airflow is not available with this option.
 5. When installing a fresh air intake kit (chamber type), two air outlet corners are closed.
 6. It is recommended that the volume of outdoor air introduced through the kit is limited to 10% of the maximum airflow rate of the indoor unit. Introducing higher quantities will increase the operating sound and may also influence temperature sensing.

7. The volume of fresh air for direct installation type is approximately 1% of the indoor unit airflow. The chamber type is recommended when more fresh air is necessary.
 8. Please order using the names of both components instead of set name.
 9. This option cannot be installed to designer panel and auto grille panel.
 10. Filter chamber is required.
 11. Please use in case temperature/humidity inside ceiling may get over 30°C, 80% RH.
 *These panels do not contain the sensing function.

Option List

VRV Indoor Units

Options of Ceiling Mounted Cassette (Round Flow with Sensing & Round Flow) Type

Options required for specific operating environments

Ultra long-life filter unit

Even in dusty environments where the air conditioning is constantly operating, the ultra long-life filter only has to be cleaned once a year.

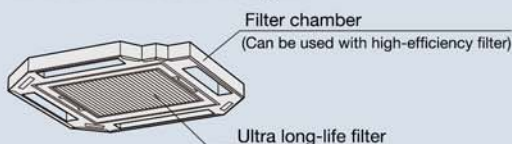

Dusty area: annual filter change

*For dust concentration of 0.3 mg/m³ (Requires separately sold Air purifier.)
1 year (Approx. 5,000 hr) ≈ 15 hr/day x 28 day/month x 12 month/year

Ordinary store or office: filter change every 4 years

*For dust concentration of 0.15 mg/m³
4 years (Approx. 10,000 hr) ≈ 8 hr/day x 25 day/month x 12 month/year
x 4 years

High-efficiency filter unit

Available in two types: 65% and 90% colorimetry.



Insulation kit for high humidity

Please use if you think the temperature and humidity inside the ceiling exceeds 30°C and RH 80%, respectively.

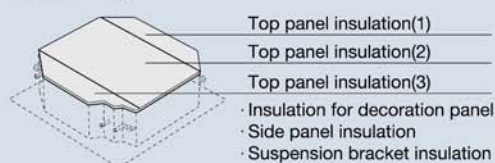

Panel spacer

Use when only minimal space is available between drop ceilings and ceiling slabs.

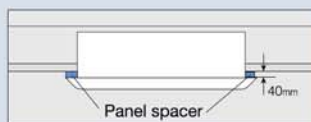

Note: Some ceiling constructions may hinder installation. Contact your Daikin Dealer before installing your unit.

Sealing material of air discharge outlet

Sealing material block air discharge openings not used in 2-way or 3-way blow.

Branch duct (direct-connection round duct)

A round duct can be attached without the need for a chamber.

A flanged port for direct connection of a round duct is provided. An existing branch duct chamber can also be fitted (square slit hole).

Fresh air intake kit Note 1.2

Using this kit, a duct can be connected to take in outdoor air. There are two chamber types that have intake in two places: with T-duct joint and without T-duct joint.

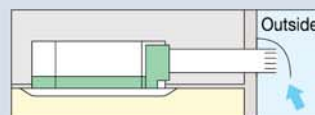

The units can be installed in the following different ways

Chamber type (without T-duct joint) Note 3.4.5

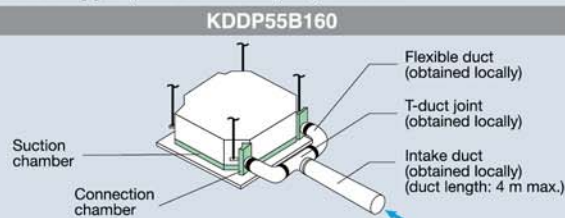

Chamber type (with T-duct joint) Note 3.4.5

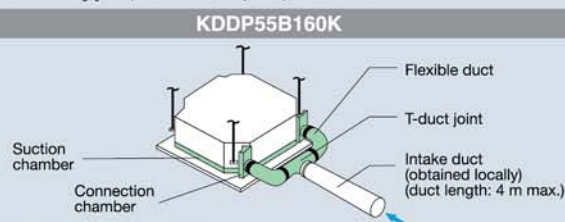

Direct installation type Note 6

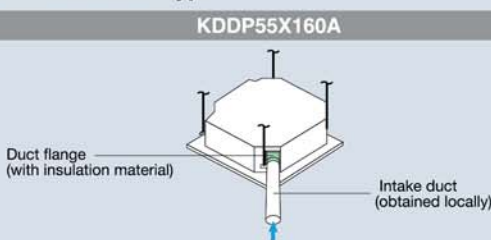

- Note: 1. Use of options will increase operating sound.
2. Connecting ducts, fan, insect nets, fire dampers, air filters, and other parts should, as required, be obtained locally.
3. When a local-obtained fan is used, an interlock with air conditioner is necessary. Optional PCB (KRP1C11A) is required for interlocking.
4. When installing a fresh air intake kit (chamber type), two air outlet corners are closed.
5. It is recommended that the volume of outdoor air introduced through the kit is limited to 10% of the maximum airflow rate of the indoor unit. Introducing higher quantities will increase the operating sound and may also influence temperature sensing.
6. The volume of fresh air for direct installation type is approximately 1% of the indoor unit airflow.
The chamber type is recommended when more fresh air is necessary.

Ceiling Mounted Cassette (Compact Multi Flow) Type

No.	Item	Type	FXZQ20M	FXZQ25M	FXZQ32M	FXZQ40M	FXZQ50M
1	Decoration panel				BYFQ60B3W1		
2	Sealing material of air discharge outlet				KDBH44BA60		
3	Panel spacer				KDBQ44BA60A		
4	Replacement long-life filter				KAFQ441BA60		
5	Fresh air intake kit	Direct installation type			KDDQ44XA60		

Ceiling Mounted Cassette (Double Flow) Type

No.	Item	Type	FXCQ20M FXCQ25M FXCQ32M	FXCQ40M	FXCQ50M	FXCQ63M	FXCQ80M	FXCQ125M
1	Decoration panel		BYBC32G-W1	BYBC50G-W1		BYBC63G-W1		BYBC125G-W1
2	Filter related	High efficiency filter 65% *1	KAFJ532G36	KAFJ532G56		KAFJ532G80		KAFJ532G160
		High efficiency filter 90% *1	KAFJ533G36	KAFJ533G56		KAFJ533G80		KAFJ533G160
		Filter chamber bottom suction	KDDFJ53G36	KDDFJ53G56		KDDFJ53G80		KDDFJ53G160
		Long life replacement filter	KAFJ531G36	KAFJ531G56		KAFJ531G80		KAFJ531G160

Note: *1 Filter chamber is required if installing high efficiency filter.

Ceiling Mounted Cassette (Single Flow) Type

No.	Item	Type	FXEQ20A FXEQ25A	FXEQ32A FXEQ40A	FXEQ50A FXEQ63A
1	Decoration panel		BYEP40AW1		BYEP63AW1

Slim Ceiling Mounted Duct Type (Standard Series)

No.	Item	Type	FXDQ20PD	FXDQ25PD	FXDQ32PD	FXDQ40ND	FXDQ50ND	FXDQ63ND
1	Insulation kit for high humidity			KDT25N32			KDT25N50	KDT25N63

Middle Static Pressure Ceiling Mounted Duct Type

No.	Item	Type	FXSQ20PA FXSQ25PA FXSQ32PA	FXSQ40PA	FXSQ50PA FXSQ63PA FXSQ80PA	FXSQ100PA FXSQ125PA	FXSQ140PA
1	High efficiency filter *1	65%	KAFP632B36	KAFP632B56	KAFP632B80	KAFP632B160	KAFP632B160B
		90%	KAFP633B36	KAFP633B56	KAFP633B80	KAFP633B160	KAFP633B160B
2	Filter chamber (for rear suction) *1		KDDFP63B36	KDDFP63B56	KDDFP63B80	KDDFP63B160	KDDFP63B160B
3	Long-life filter *1		KAFP631B36	KAFP631B56	KAFP631B80	KAFP631B160	KAFP631B160B
4	Service panel	White	KTBJ25K36W	KTBJ25K56W	KTBJ25K80W	KTBJ25K160W	
		Fresh white	KTBJ25K36F	KTBJ25K56F	KTBJ25K80F	KTBJ25K160F	
		Brown	KTBJ25K36T	KTBJ25K56T	KTBJ25K80T	KTBJ25K160T	
5	Air discharge adaptor		KDAP25A36A	KDAP25A56A	KDAP25A71A	KDAP25A140A	KDAP25A160A *2
6	Shield plate for side plate		KDBD63A160				—

Note: *1. If installing high efficiency filter and long-life filter to the unit, filter chamber is required.

*2. This option is a set of KDAP25A140A and KDBHP37A160.

Ceiling Mounted Duct Type

No.	Item	Type	FXMQ20PA FXMQ25PA FXMQ32PA	FXMQ40PA	FXMQ50PA FXMQ63PA FXMQ80PA	FXMQ100PA FXMQ125PA FXMQ140PA	FXMQ200MA FXMQ250MA
1	Drain pump kit						KDU30L250VE
2	High efficiency filter	65%	KAF372AA36	KAF372AA56	KAF372AA80	KAF372AA160	KAFJ372L280
		90%	KAF373AA36	KAF373AA56	KAF373AA80	KAF373AA160	KAFJ373L280
3	Filter chamber		KDDF37AA36	KDDF37AA56	KDDF37AA80	KDDF37AA160	KDJ3705L280
4	Long life replacement filter		KAF371AA36	KAF371AA56	KAF371AA80	KAF371AA160	KAFJ371L280
5	Long life filter chamber kit		KAF375AA36	KAF375AA56	KAF375AA80	KAF375AA160	
6	Service panel	White	KTBJ25K36W	KTBJ25K56W	KTBJ25K80W	KTBJ25K160W	—
		Fresh white	KTBJ25K36F	KTBJ25K56F	KTBJ25K80F	KTBJ25K160F	
		Brown	KTBJ25K36T	KTBJ25K56T	KTBJ25K80T	KTBJ25K160T	
7	Air discharge adaptor		KDAJ25K36A	KDAJ25K56A	KDAJ25K71A	KDAJ25K140A	

Option List

VRV Indoor Units

4-Way Flow Ceiling Suspended Type

No.	Item	Type	FXUQ71A	FXUQ100A
1	Sealing material of air discharge outlet			KDBHP49B140
2	Decoration panel for air discharge			KDBTP49B140
3	Replacement long-life filter			KAFP551K160

Ceiling Suspended Type

No.	Item	Type	FXHQ32MA	FXHQ63MA	FXHQ100MA
1	Drain pump kit		KDU50N60VE		KDU50N125VE
2	Replacement long-life filter (Resin net)		KAF501DA56	KAF501DA80	KAF501DA112
3	L-type piping kit (for upward direction)		KHFP5MA63		KHFP5MA160

Wall Mounted Type

No.	Item	Type	FXAQ20P	FXAQ25P	FXAQ32P	FXAQ40P	FXAQ50P	FXAQ63P
1	Drain pump kit							K-KDU572EVE

Floor Standing Type

No.	Item	Type	FXLQ20MA	FXLQ25MA	FXLQ32MA	FXLQ40MA	FXLQ50MA	FXLQ63MA
1	Long life replacement filter		KAFJ361K28		KAFJ361K45			KAFJ361K71

Concealed Floor Standing Type

No.	Item	Type	FXNQ20MA	FXNQ25MA	FXNQ32MA	FXNQ40MA	FXNQ50MA	FXNQ63MA
1	Long life replacement filter		KAFJ361K28		KAFJ361K45			KAFJ361K71

Floor Standing Duct Type

No.	Item	Type	FXVQ125N	FXVQ200N	FXVQ250N	FXVQ400N	FXVQ500N		
1	Replacement long life filter		KAFJ261L140	KAFJ261L224	KAFJ261L280	KAFJ261M450	KAFJ261M560		
2	Ultra long-life filter					KAFSJ9A400	KAFSJ9A560		
3	Front suction filter chamber for high efficiency filter	Front suction base flange	KD-9A140	KD-9A200	KD-9A280	KD-9A400	KD-9A560		
4		Suction grille	KDGF-9A140	KDGF-9A200	KDGF-9A280	KDGF-9A400	KDGF-9A560		
5		Filter chamber for high efficiency filter	Replacement long-life filter *1, 2, 3	KAF-91A140	KAF-91A200	KAF-91A280	KAF-91A400	KAF-91A560	
6			Replacement high efficiency filter	65% *1, 3	KAF-92A140	KAF-92A200	KAF-92A280	KAF-92A400	KAF-92A560
7				90% *2, 3	KAF-93A140	KAF-93A200	KAF-93A280	KAF-93A400	KAF-93A560
8		Filter chamber *1, 2	KDDF-9A140	KDDF-9A200	KDDF-9A280	KDDF-9A400	KDDF-9A560		
9		Plenum chamber *4	KPCJ140A	KPC5J	KPC8J	KPCJ400A	KPC15JA		
10		Pulley for plenum chamber *4	KPP8JA	KPP9JA	KPP10JA		-		
11	Fresh air intake kit		KD106D10			KDFJ906A560			
12	Rear suction kit		KDFJ905A140	KDFJ905A200	KDFJ905A280	KDFJ905A400	KDFJ905A560		
13	Discharge grille for plenum side		KD101A10			KD101A20			
14	Wood base		KKWJ9A140	KWF1G5P	KWF1G8P	KKWJ9A400	KWF1G15		
15	Vibration isolating frame		K-ABSG1406A	K-ABSG1407A	K-ABSG1408A	K-ABSG1409A	K-ABSG1410A		

Note: *1. When ordering a filter chamber for high efficiency filter (65%), please order with all the respective parts.
 *2. When ordering a filter chamber for high efficiency filter (90%), please order with all the respective parts.
 *3. When replacing with a new filter, please order the replacement filters with the corresponding filter model name.
 *4. Use the plenum chamber and pulley for plenum chamber in combination.

Clean Room Air Conditioner

No.	Item	Type	FXBQ40PVE	FXBQ50PVE	FXBQ63PVE	FXBPQ63PVE
1	Outlet unit					BAFH82A63
2	Filter	HEPA filter	BAFH82A50			BAFH82A63
3	Panel	Ceiling intake type	BYB82A50C			BYB82A63CP
4		Floor-level intake type	BYB82A50W			BYB82A63WP
5	Outside air intake duct flange		KDFJ82A80			

Residential Indoor Units with connection to BP units

Slim Ceiling Mounted Duct Type

No.	Item	Type	FDKS25EAVMB	FDKS35EAVMB	FDKS25CAVMB	FDKS35CAVMB	FDKS50CVMB	FDKS60CVMB
1	Insulation kit for high humidity		KDT25N32		KDT25N50			KDT25N63

Wall Mounted Type

No.	Item	Type	FTKJ25NVMW FTKJ25NVMS	FTKJ35NVMW FTKJ35NVMS	FTKJ50NVMW FTKJ50NVMS	FTKS25DVM FTKS35DVM	FTKS50BVMA	FTKS50FVM FTKS60FVM FTKS71FVM
1	Titanium apatite deodorising filter		KAF970A46				KAF952A42	KAF952B42

Note: Filter is a standard accessory. It should be replaced approximately 3 years.

BP Units for connection to residential indoor units

No.	Item	Type	BPMKS967A2	BPMKS967A3
1	REFNET joint		KHRP26A22T	

Note: A single BP unit does not require a REFNET joint. 2 BP units require only 1 REFNET joint, and 3 BP units require only 2 REFNET joints.

Option List

Control Systems

Operation Control System Optional Accessories

For VRV indoor unit use

No.	Item	Type	FXFSQ-A FXFQ-A	FXZQ-M	FXCQ-M	FXEQ-A	FXDQ-PD FXDQ-ND	FXDQ-SP	FXSQ-PA	FXMQ-PA
1	Remote controller	Wireless	BRC7M635F (Fresh White) BRC7M635K (Black)	BRC7E531W	BRC7C67	BRC4M63	BRC4C66			
		Wired	—	BRC1C62		—	BRC1C62			
2	Navigation remote controller (Wired remote controller)		BRC1E63 Note 7	BRC1E63		BRC1F61	BRC1E63 Note 8	BRC1E63	BRC1E63 Note 8	
3	Simplified remote controller (Exposed type)		—				BRC2C51			
4	Remote controller for hotel use (Concealed type)		—				BRC3A61			
5	Adaptor for wiring		★KRP1C11A	★KRP1BA57	★KRP1B61	—	★KRP1B56	—	★KRP1C64	
6-1	Wiring adaptor for electrical appendices (1)		—	★KRP2A62	★KRP2A61	—	★KRP2A53	—	★KRP2A61	
6-2	Wiring adaptor for electrical appendices (2)		★KRP4AA53		★KRP4AA51	—	★KRP4A54	—	★KRP4AA51	
7	Remote sensor (for indoor temperature)		KRCS01-5B	KRCS01-1B		KRCS01-4B		KRCS01-1B		
8	Installation box for adaptor PCB ☆		Note 2, 3 KRP1H98A	Note 4, 6 KRP1BA101	Note 2, 3 KRP1B96	—	Note 4, 6 KRP1BA101	—	Note 2, 3 KRP4A98	Note 2, 3 KRP4A97
9	External control adaptor for outdoor unit		★DTA104A62		★DTA104A61	—	★DTA104A53	—	★DTA104A61	
10	Adaptor for multi tenant		★DTA114A61		—	—				★DTA114A61

No.	Item	Type	FXMQ-MA	FXUQ-A	FXHQ-MA	FXAQ-P	FXLQ-MA FXNQ-MA	FXVQ-N	FXBQ-P FXBPQ-P
1	Remote controller	Wireless	BRC4C64	BRC7CB59	BRC7EA66	BRC7EA619	BRC4C64	—	BRC4C64
		Wired	BRC1C62				BRC1C62		
2	Navigation remote controller (Wired remote controller)		BRC1E63	BRC1E63 Note 7, 8	BRC1E63			BRC1E63 Note 10	BRC1E63
3	Simplified remote controller (Exposed type)		BRC2C51	—			BRC2C51	—	BRC2C51
4	Remote controller for hotel use (Concealed type)		BRC3A61	—			BRC3A61	—	BRC3A61
5	Adaptor for wiring		KRP1B61	—	KRP1BA54	—	KRP1B61	KRP1C67	KRP1B61
6-1	Wiring adaptor for electrical appendices (1)		KRP2A61	—	★KRP2A62	★KRP2A61	KRP2A61	KRP2A62	KRP2A61
6-2	Wiring adaptor for electrical appendices (2)		KRP4AA51	★KRP4AA53	★KRP4AA52	★KRP4AA51	KRP4AA51	—	KRP4AA51
7	Remote sensor (for indoor temperature)		KRCS01-1B	KRCS01-4B	KRCS01-1B				
8	Installation box for adaptor PCB ☆		—	KRP1BA97	Note 3 KRP1CA93	Note 2, 3 KRP4AA93	—		
9	External control adaptor for outdoor unit		DTA104A61	—	★DTA104A62	★DTA104A61	DTA104A61	Note 11 DTA104A62	DTA104A61
10	Adaptor for multi tenant		—			★DTA114A61	—		
11	External control adaptor for cooling/heating		—					KRP6A1 Note 11	—
12	Remote controller with key		—					KRCB37-1	—

- Note: 1. Installation box☆ is necessary for each adaptor marked★.
 2. Up to 2 adaptors can be fixed for each installation box.
 3. Only one installation box can be installed for each indoor unit.
 4. Up to 2 installation boxes can be installed for each indoor unit.
 5. Installation box☆ is necessary for second adaptor.
 6. Installation box☆ is necessary for each adaptor.
 7. Some function can be set only via wired remote controller BRC1E63. Cannot be set via other remote controllers. Please refer to page 22 for function list details.
 8. Auto airflow rate can be set only via wired remote controller BRC1E63. Cannot be set via other remote controllers.
 9. Since the control panel is equipped as standard, use the option for 2 remote control system.
 10. When using BRC1E63, be sure to remove the control panel and since BRC1E63 cannot be stored inside the indoor unit, please place it separately.
 11. Remove the group control adaptor which is a standard equipment before mounting KRP6A1 and DTA104A62.
 KRP6A1 and DTA104A62 cannot be mounted to the same indoor unit at the same time.

For residential indoor unit use

No.	Item	Type	FDKS-EA, C(A)	FTKJ-N	FTKS-D,B,F
1	Remote controller	Wireless type	— Note 1		
2	Wiring adaptor for time clock/remote controller Note 2 (Normal open pulse contact/normal open contact)		KRP413AB1S		
3	Remote controller loss prevention chain		KKF917A4	KKF910A4	KKF917A4
4	Interface adaptor for DIII-NET use		KRP928BB2S		

- Note: 1. A wireless remote controller is a standard accessory.
 2. Time clock and other devices should be obtained locally.

Control Systems

System Configuration

No.	Item	Model No.	Function
1	Residential central remote controller	Note 2 DCS303A51	• Up to 16 groups of indoor units (128 units) can be easily controlled using the large LCD panel. ON/OFF, temperature settings and scheduling can be controlled individually for indoor units.
2	Interface adaptor for residential indoor units	KRP928BB2S	• Adaptors required to connect products other than those of the VRV System to the high-speed DIII-NET communication system adopted for the VRV System. * To use any of the above optional controllers, an appropriate adaptor must be installed on the product unit to be controlled.
3	Interface adaptor for SkyAir-series	Note 3 ★DTA112BA51	
4	Central control adaptor kit For UAT(Y)-K(A),FD-K	★DTA107A55	
5	Wiring adaptor for other air-conditioner	★DTA103A51	
6	DIII-NET expander adaptor	DTA109A51	
6-1	Mounting plate	KRP4A92	• Up to 1024 units can be centrally controlled in 64 different groups. • Wiring restrictions (max. length: 1,000m, total wiring length: 2,000m, max. number of branches: 16) apply to each adaptor. • Fixing plate for DTA109A51

Note: 1. Installation box for ★ adaptor must be obtained locally.
2. For residential use only. Cannot be used with other centralised control equipment.
3. No adaptor is required for some indoor units.

Building Management System

No.	Item			Model No.	Function	
1	intelligent Touch Controller	Basic	Hardware	intelligent Touch Controller	DCS601C51	• Air-Conditioning management system that can be controlled by a compact all-in-one unit.
1-1		Option	Hardware	DIII-NET plus adaptor	DCS601A52	• Additional 64 groups (10 outdoor units) is possible.
1-2	Electrical box with earth terminal (4 blocks)				KJB411A	• Wall embedded switch box.
2	intelligent Touch Manager	Basic	Hardware	intelligent Touch Manager	DCM601A51	• Air-conditioning management system that can be controlled by touch screen.
2-1				Hardware	iTM plus adaptor	DCM601A52
2-2		Option	Software	iTM power proportional distribution	DCM002A51	• Power consumption of indoor units are calculated based on operation status of the indoor unit and outdoor unit power consumption measured by kWh metre.
2-3				iTM energy navigator	DCM008A51	• Building energy consumption is visualised. Wasted air-conditioning energy can be found out.
2-4				BACnet® client	DCM009A51	• BACnet® equipment can be managed by intelligent Touch Manager.
2-5				HTTP Interface	DCM007A51	• Interface for intelligent Touch Manager by HTTP
2-6		Hardware	*1 SVM series	SVMPR2		• VRV Smart phone Control System for residence
2-7				SVMPC2		• VRV Smart Phone Remote Controller for building
2-8				SVMPS1		• Tenant Billing System with PPD
2-9	VRV Smart Phone Control System			SVMPR1	• VRV Smart Phone Control System for residence with DTA116A51.	
2-10	VRV Tablet Controller			SVMPC1	• VRV Tablet Controller for small size building with DTA116A51	
2-11	Di unit			DEC101A51	• 8 pairs based on a pair of ON/OFF input and abnormality input.	
2-12	Dio unit			DEC102A51	• 4 pairs based on a pair of ON/OFF input and abnormality input.	
3	Communication interface	*2 Interface for use in BACnet®			DMS502B51	• Interface unit to allow communications between VRV and BMS. Operation and monitoring of air-conditioning systems through BACnet® communication.
3-1		Optional DIII board			DAM411B51	• Expansion kit, installed on DMS502B51, to provide 2 more DIII-NET communication ports. Not usable independently.
3-2		Optional Di board			DAM412B51	• Expansion kit, installed on DMS502B51, to provide 16 more wattmeter pulse input points. Not usable independently.
4		*3 Interface for use in LONWORKS®			DMS504B51	• Interface unit to allow communications between VRV and BMS. Operation and monitoring of air-conditioning systems through LonWorks® communication.
5		Home Automation Interface Adaptor			DTA116A51	• Use of the Modbus protocol enables the connection of the VRV system with a variety of home automation systems from other manufacturers.
6	Contact/ analogue signal	Unification adaptor for computerised control			★DCS302A52	• Interface between the central monitoring board and central control units.

Note: *1. HTTP interface (DCM007A51) is also required.
*2. BACnet® is a registered trademark of American Society of Heating, Refrigerating and Air-Conditioning Engineers (ASHRAE).
*3. LonWorks® is a trademark of Echelon Corporation registered in the United States and other countries.
*4. Installation box for ★ adaptor must be obtained locally.

Free Combination Specifications

System Capacity			12HP			14HP		
Model Name (Independent Unit)			RXQ6AYM+ RXQ6AYM	RXQ6AY14+ RXQ6AY14	RXQ6AY1S+ RXQ6AY1S	RXQ6AYM+ RXQ8AYM	RXQ6AY14+ RXQ8AY14	RXQ6AY1S+ RXQ8AY1S
Power Supply			3 phase, 380-415/380 V, 50/60 Hz			3 phase, 380-415 V, 50 Hz		
★1 Cooling Capacity	kcal/h		27,500			33,000		
	Btu/h		109,000			131,000		
	kW		32.0			38.4		
Casing Color			Ivory white (5Y7.5/1)			Ivory white (5Y7.5/1)		
Dimensions: (HxWxD)			mm (1,657x930x765)+(1,657x930x765)			mm (1,657x930x765)+(1,657x930x765)		
Heat Exchanger			Cross fin coil			Cross fin coil		
Compressor	Type		Hermetically sealed scroll type			Hermetically sealed scroll type		
	Motor Outputx Number of Units	kW	(2.3x1)+(2.3x1)			(2.3x1)+(3.4x1)		
	Starting Method		Soft start			Soft start		
Fan	Type		Propeller fan			Propeller fan		
	Motor Output	kW	(0.55x1)+(0.55x1)			(0.55x1)+(0.55x1)		
	Airflow Rate	m³/min	119+119			119+178		
	Drive		Direct drive			Direct drive		
Connecting Pipes	Liquid Pipe	mm	φ12.7 C1220T (Brazing connection)			φ12.7 C1220T (Brazing connection)		
	Gas Pipe	mm	φ28.6 C1220T (Brazing connection)			φ28.6 C1220T (Brazing connection)		
Mass			kg 175+175			kg 175+175		
★2 Sound pressure level			dB(A) 59			dB(A) 59		
Safety Devices			High pressure switch, Fan driver overload protector, Over current relay, Inverter overload protector			High pressure switch, Fan driver overload protector, Over current relay, Inverter overload protector		
Capacity Control			% 12-100			% 11-100		
Refrigerant	Refrigerant Name		R410A			R410A		
	Charge	kg	5.9+5.9			5.9+5.9		
	Control		Electronic expansion valve			Electronic expansion valve		
Refrigerator Oil			Refer to the nameplate of compressor			Refer to the nameplate of compressor		
Standard Accessories			Installation manual, Operation manual, Connection pipes, Clamps			Installation manual, Operation manual, Connection pipes, Clamps		
Drawing No.	Specifications		—			—		
	Sound level		—			—		

System Capacity			16HP			18HP		
Model Name (Independent Unit)			RXQ8AYM+ RXQ8AYM	RXQ8AY14+ RXQ8AY14	RXQ8AY1S+ RXQ8AY1S	RXQ6AYM+ RXQ6AYM+ RXQ6AYM	RXQ6AY14+ RXQ6AY14+ RXQ6AY14	RXQ6AY1S+ RXQ6AY1S+ RXQ6AY1S
Power Supply			3 phase, 380-415/380 V, 50/60 Hz			3 phase, 380-415 V, 50 Hz		
★1 Cooling Capacity	kcal/h		38,500			41,300		
	Btu/h		153,000			164,000		
	kW		44.8			48.0		
Casing Color			Ivory white (5Y7.5/1)			Ivory white (5Y7.5/1)		
Dimensions: (HxWxD)			mm (1,657x930x765)+(1,657x930x765)			mm (1,657x930x765)+(1,657x930x765)+(1,657x930x765)		
Heat Exchanger			Cross fin coil			Cross fin coil		
Compressor	Type		Hermetically sealed scroll type			Hermetically sealed scroll type		
	Motor Outputx Number of Units	kW	(3.4x1)+(3.4x1)			(2.3x1)+(2.3x1)+(2.3x1)		
	Starting Method		Soft start			Soft start		
Fan	Type		Propeller fan			Propeller fan		
	Motor Output	kW	(0.55x1)+(0.55x1)			(0.55x1)+(0.55x1)+(0.55x1)		
	Airflow Rate	m³/min	178+178			119+119+119		
	Drive		Direct drive			Direct drive		
Connecting Pipes	Liquid Pipe	mm	φ12.7 C1220T (Brazing connection)			φ15.9 C1220T (Brazing connection)		
	Gas Pipe	mm	φ28.6 C1220T (Brazing connection)			φ28.6 C1220T (Brazing connection)		
Mass			kg 175+175			kg 175+175+175		
★2 Sound pressure level			dB(A) 59			dB(A) 61		
Safety Devices			High pressure switch, Fan driver overload protector, Over current relay, Inverter overload protector			High pressure switch, Fan driver overload protector, Over current relay, Inverter overload protector		
Capacity Control			% 10-100			% 8-100		
Refrigerant	Refrigerant Name		R410A			R410A		
	Charge	kg	5.9+5.9			5.9+5.9+5.9		
	Control		Electronic expansion valve			Electronic expansion valve		
Refrigerator Oil			Refer to the nameplate of compressor			Refer to the nameplate of compressor		
Standard Accessories			Installation manual, Operation manual, Connection pipes, Clamps			Installation manual, Operation manual, Connection pipes, Clamps		
Drawing No.	Specifications		—			—		
	Sound level		—			—		

Notes:

- ★1. Indoor temp.: 27°CDB, 19°CWB / outdoor temp.: 35°CDB / Equivalent piping length: 7.5 m, level difference: 0 m.
- ★2. Anechoic chamber conversion value, measured at a point 1 m in front of the unit at a height of 1.5 m.
During actual operation, these values are normally somewhat higher as a result of ambient conditions.

Conversion formulae
kcal/h=kWx860
Btu/h=kWx3412
cfm=m³/minx35.3

System Capacity			20HP		
Model Name (Independent Unit)			RXQ6AYM+ RXQ6AYM+ RXQ8AYM	RXQ6AY14+ RXQ6AY14+ RXQ8AY14	RXQ6AY1S+ RXQ6AY1S+ RXQ8AY1S
Power Supply			3 phase, 380-415/380 V, 50/60 Hz	3 phase, 380-415 V, 50 Hz	3 phase, 380-415 V, 50 Hz
★1 Cooling Capacity	kcal/h		46,800		
	Btu/h		186,000		
	kW		54.4		
Casing Color			Ivory white (5Y7.5/1)		
Dimensions: (HxWxD)			mm (1,657x930x765)+(1,657x930x765)+(1,657x930x765)		
Heat Exchanger			Cross fin coil		
Compressor	Type		Hermetically sealed scroll type		
	Motor Outputx Number of Units	kW	(2.3x1)+(2.3x1)+(3.4x1)		
	Starting Method		Soft start		
Fan	Type		Propeller fan		
	Motor Output	kW	(0.55x1)+(0.55x1)+(0.55x1)		
	Airflow Rate	m³/min	119+119+178		
	Drive		Direct drive		
Connecting Pipes	Liquid Pipe	mm	φ15.9 C1220T (Brazing connection)		
	Gas Pipe	mm	φ28.6 C1220T (Brazing connection)		
Mass			kg 175+175+175		
★2 Sound pressure level			dB(A) 61		
Safety Devices			High pressure switch, Fan driver overload protector, Over current relay, Inverter overload protector		
Capacity Control			% 8-100		
Refrigerant	Refrigerant Name		R410A		
	Charge	kg	5.9+5.9+5.9		
	Control		Electronic expansion valve		
Refrigerator Oil			Refer to the nameplate of compressor		
Standard Accessories			Installation manual, Operation manual, Connection pipes, Clamps		
Drawing No.	Specifications		—		
	Sound level		—		

System Capacity			22HP			22HP		
Model Name (Independent Unit)			RXQ8AYM+ RXQ14AYM	RXQ8AY14+ RXQ14AY14	RXQ8AY1S+ RXQ14AY1S	RXQ6AYM+ RXQ8AYM+ RXQ8AYM	RXQ6AY14+ RXQ8AY14+ RXQ8AY14	RXQ6AY1S+ RXQ8AY1S+ RXQ8AY1S
Power Supply			3 phase, 380-415/380 V, 50/60 Hz	3 phase, 380-415 V, 50 Hz	3 phase, 380-415 V, 50 Hz	3 phase, 380-415/380 V, 50/60 Hz	3 phase, 380-415 V, 50 Hz	3 phase, 380-415 V, 50 Hz
★1 Cooling Capacity	kcal/h		53,700			52,300		
	Btu/h		213,000			207,000		
	kW		62.4			60.8		
Casing Color			Ivory white (5Y7.5/1)			Ivory white (5Y7.5/1)		
Dimensions: (HxWxD)			mm (1,657x930x765)+(1,657x1,240x765)			mm (1,657x930x765)+(1,657x930x765)+(1,657x930x765)		
Heat Exchanger			Cross fin coil			Cross fin coil		
Compressor	Type		Hermetically sealed scroll type			Hermetically sealed scroll type		
	Motor Outputx Number of Units	kW	(3.4x1)+(6.4x1)			(2.3x1)+(3.4x1)+(3.4x1)		
	Starting Method		Soft start			Soft start		
Fan	Type		Propeller fan			Propeller fan		
	Motor Output	kW	(0.55x1)+(0.75x2)			(0.55x1)+(0.55x1)+(0.55x1)		
	Airflow Rate	m³/min	178+257			119+178+178		
	Drive		Direct drive			Direct drive		
Connecting Pipes	Liquid Pipe	mm	φ15.9 C1220T (Brazing connection)			φ15.9 C1220T (Brazing connection)		
	Gas Pipe	mm	φ28.6 C1220T (Brazing connection)			φ28.6 C1220T (Brazing connection)		
Mass			kg 175+215			kg 175+175+175		
★2 Sound pressure level			dB(A) 61			dB(A) 61		
Safety Devices			High pressure switch, Fan driver overload protector, Over current relay, Inverter overload protector			High pressure switch, Fan driver overload protector, Over current relay, Inverter overload protector		
Capacity Control			% 7-100			% 7-100		
Refrigerant	Refrigerant Name		R410A			R410A		
	Charge	kg	5.9+7.4			5.9+5.9+5.9		
	Control		Electronic expansion valve			Electronic expansion valve		
Refrigerator Oil			Refer to the nameplate of compressor			Refer to the nameplate of compressor		
Standard Accessories			Installation manual, Operation manual, Connection pipes, Clamps			Installation manual, Operation manual, Connection pipes, Clamps		
Drawing No.	Specifications		—			—		
	Sound level		—			—		

Notes:

- ★1. Indoor temp.: 27°CDB, 19°CWB / outdoor temp.: 35°CDB / Equivalent piping length: 7.5 m, level difference: 0 m.
★2. Anechoic chamber conversion value, measured at a point 1 m in front of the unit at a height of 1.5 m.
During actual operation, these values are normally somewhat higher as a result of ambient conditions.

Conversion formulae
kcal/h=kWx860
Btu/h=kWx3412
cfm=m³/minx35.3

Free Combination Specifications

System Capacity			24HP			24HP		
Model Name (Independent Unit)			RXQ10AYM+ RXQ14AYM	RXQ10AY14+ RXQ14AY14	RXQ10AY1S+ RXQ14AY1S	RXQ8AYM+ RXQ8AYM+ RXQ8AYM	RXQ8AY14+ RXQ8AY14+ RXQ8AY14	RXQ8AY1S+ RXQ8AY1S+ RXQ8AY1S
Power Supply			3 phase, 380-415/380 V, 50/60 Hz	3 phase, 380-415 V, 50 Hz	3 phase, 380-415 V, 50 Hz	3 phase, 380-415/380 V, 50/60 Hz	3 phase, 380-415 V, 50 Hz	3 phase, 380-415 V, 50 Hz
★1 Cooling Capacity	kcal/h		58,500			57,800		
	Btu/h		232,000			229,000		
	kW		68.0			67.2		
Casing Color			Ivory white (5Y7.5/1)			Ivory white (5Y7.5/1)		
Dimensions: (HxWxD)			mm (1,657x930x765)+(1,657x1,240x765)			mm (1,657x930x765)+(1,657x930x765)+(1,657x930x765)		
Heat Exchanger			Cross fin coil			Cross fin coil		
Compressor	Type		Hermetically sealed scroll type			Hermetically sealed scroll type		
	Motor Outputx Number of Units		kW (4.5x1)+(6.4x1)			kW (3.4x1)+(3.4x1)+(3.4x1)		
	Starting Method		Soft start			Soft start		
Fan	Type		Propeller fan			Propeller fan		
	Motor Output		kW (0.55x1)+(0.75x2)			kW (0.55x1)+(0.55x1)+(0.55x1)		
	Airflow Rate		m ³ /min 178+257			m ³ /min 178+178+178		
	Drive		Direct drive			Direct drive		
Connecting Pipes	Liquid Pipe		mm φ15.9 C1220T (Brazing connection)			mm φ15.9 C1220T (Brazing connection)		
	Gas Pipe		mm φ34.9 C1220T (Brazing connection)			mm φ34.9 C1220T (Brazing connection)		
Mass			kg 185+215			kg 175+175+175		
★2 Sound pressure level			dB(A) 62			dB(A) 61		
Safety Devices			High pressure switch, Fan driver overload protector, Over current relay, Inverter overload protector			High pressure switch, Fan driver overload protector, Over current relay, Inverter overload protector		
Capacity Control			% 6-100			% 7-100		
Refrigerant	Refrigerant Name		R410A			R410A		
	Charge		kg 6.7+7.4			kg 5.9+5.9+5.9		
	Control		Electronic expansion valve			Electronic expansion valve		
Refrigerator Oil			Refer to the nameplate of compressor			Refer to the nameplate of compressor		
Standard Accessories			Installation manual, Operation manual, Connection pipes, Clamps			Installation manual, Operation manual, Connection pipes, Clamps		
Drawing No.	Specifications		—			—		
	Sound level		—			—		

System Capacity			26HP			26HP		
Model Name (Independent Unit)			RXQ8AYM+ RXQ18AYM	RXQ8AY14+ RXQ18AY14	RXQ8AY1S+ RXQ18AY1S	RXQ8AYM+ RXQ8AYM+ RXQ10AYM	RXQ8AY14+ RXQ8AY14+ RXQ10AY14	RXQ8AY1S+ RXQ8AY1S+ RXQ10AY1S
Power Supply			3 phase, 380-415/380 V, 50/60 Hz	3 phase, 380-415 V, 50 Hz	3 phase, 380-415 V, 50 Hz	3 phase, 380-415/380 V, 50/60 Hz	3 phase, 380-415 V, 50 Hz	3 phase, 380-415 V, 50 Hz
★1 Cooling Capacity	kcal/h		62,300			62,600		
	Btu/h		247,000			248,000		
	kW		72.4			72.8		
Casing Color			Ivory white (5Y7.5/1)			Ivory white (5Y7.5/1)		
Dimensions: (HxWxD)			mm (1,657x930x765)+(1,657x1,240x765)			mm (1,657x930x765)+(1,657x930x765)+(1,657x930x765)		
Heat Exchanger			Cross fin coil			Cross fin coil		
Compressor	Type		Hermetically sealed scroll type			Hermetically sealed scroll type		
	Motor Outputx Number of Units		kW (3.4x1)+(4.0x1)+(4.0x1)			kW (3.4x1)+(3.4x1)+(4.5x1)		
	Starting Method		Soft start			Soft start		
Fan	Type		Propeller fan			Propeller fan		
	Motor Output		kW (0.55x1)+(0.75x2)			kW (0.55x1)+(0.55x1)+(0.55x1)		
	Airflow Rate		m ³ /min 178+257			m ³ /min 178+178+178		
	Drive		Direct drive			Direct drive		
Connecting Pipes	Liquid Pipe		mm φ19.1 C1220T (Brazing connection)			mm φ19.1 C1220T (Brazing connection)		
	Gas Pipe		mm φ34.9 C1220T (Brazing connection)			mm φ34.9 C1220T (Brazing connection)		
Mass			kg 175+260			kg 175+175+185		
★2 Sound pressure level			dB(A) 62			dB(A) 61		
Safety Devices			High pressure switch, Fan driver overload protector, Over current relay, Inverter overload protector			High pressure switch, Fan driver overload protector, Over current relay, Inverter overload protector		
Capacity Control			% 7-100			% 5-100		
Refrigerant	Refrigerant Name		R410A			R410A		
	Charge		kg 5.9+8.4			kg 5.9+5.9+6.7		
	Control		Electronic expansion valve			Electronic expansion valve		
Refrigerator Oil			Refer to the nameplate of compressor			Refer to the nameplate of compressor		
Standard Accessories			Installation manual, Operation manual, Connection pipes, Clamps			Installation manual, Operation manual, Connection pipes, Clamps		
Drawing No.	Specifications		—			—		
	Sound level		—			—		

Notes:

★1. Indoor temp.: 27°CDB, 19°CWB / outdoor temp.: 35°CDB / Equivalent piping length: 7.5 m, level difference: 0 m.

★2. Anechoic chamber conversion value, measured at a point 1 m in front of the unit at a height of 1.5 m.

During actual operation, these values are normally somewhat higher as a result of ambient conditions.

Conversion formulae

kcal/h=kWx860
Btu/h=kWx3412
cfm=m³/minx35.3

System Capacity			28HP			28HP		
Model Name (Independent Unit)			RXQ14AYM+ RXQ14AYM	RXQ14AY14+ RXQ14AY14	RXQ14AY1S+ RXQ14AY1S	RXQ8AYM+ RXQ8AYM+ RXQ12AYM	RXQ8AY14+ RXQ8AY14+ RXQ12AY14	RXQ8AY1S+ RXQ8AY1S+ RXQ12AY1S
Power Supply			3 phase, 380-415/380 V, 50/60 Hz			3 phase, 380-415 V, 50 Hz		
★1 Cooling Capacity	kcal/h		68,800			67,300		
	Btu/h		273,000			267,000		
	kW		80.0			78.3		
Casing Color			Ivory white (5Y7.5/1)			Ivory white (5Y7.5/1)		
Dimensions: (HxWxD)			mm (1,657x1,240x765)+(1,657x1,240x765)			mm (1,657x930x765)+(1,657x930x765)+(1,657x930x765)		
Heat Exchanger			Cross fin coil			Cross fin coil		
Compressor	Type		Hermetically sealed scroll type			Hermetically sealed scroll type		
	Motor Outputx Number of Units	kW	(6.4x1)+(6.4x1)			(3.4x1)+(3.4x1)+(5.6x1)		
	Starting Method		Soft start			Soft start		
Fan	Type		Propeller fan			Propeller fan		
	Motor Output	kW	(0.75x2)+(0.75x2)			(0.55x1)+(0.55x1)+(0.55x1)		
	Airflow Rate	m³/min	257+257			178+178+191		
	Drive		Direct drive			Direct drive		
Connecting Pipes	Liquid Pipe	mm	φ19.1 C1220T (Braze connection)			φ19.1 C1220T (Braze connection)		
	Gas Pipe	mm	φ34.9 C1220T (Braze connection)			φ34.9 C1220T (Braze connection)		
Mass			kg 215+215			kg 175+175+185		
★2 Sound pressure level			dB(A) 63			dB(A) 62		
Safety Devices			High pressure switch, Fan driver overload protector, Over current relay, Inverter overload protector			High pressure switch, Fan driver overload protector, Over current relay, Inverter overload protector		
Capacity Control			% 5-100			% 5-100		
Refrigerant	Refrigerant Name		R410A			R410A		
	Charge	kg	7.4+7.4			5.9+5.9+6.8		
	Control		Electronic expansion valve			Electronic expansion valve		
Refrigerator Oil			Refer to the nameplate of compressor			Refer to the nameplate of compressor		
Standard Accessories			Installation manual, Operation manual, Connection pipes, Clamps			Installation manual, Operation manual, Connection pipes, Clamps		
Drawing No.	Specifications		—			—		
	Sound level		—			—		

System Capacity			30HP			30HP		
Model Name (Independent Unit)			RXQ14AYM+ RXQ16AYM	RXQ14AY14+ RXQ16AY14	RXQ14AY1S+ RXQ16AY1S	RXQ8AYM+ RXQ10AYM+ RXQ12AYM	RXQ8AY14+ RXQ10AY14+ RXQ12AY14	RXQ8AY1S+ RXQ10AY1S+ RXQ12AY1S
Power Supply			3 phase, 380-415/380 V, 50/60 Hz			3 phase, 380-415 V, 50 Hz		
★1 Cooling Capacity	kcal/h		73,100			72,200		
	Btu/h		290,000			286,000		
	kW		85.0			83.9		
Casing Color			Ivory white (5Y7.5/1)			Ivory white (5Y7.5/1)		
Dimensions: (HxWxD)			mm (1,657x1,240x765)+(1,657x1,240x765)			mm (1,657x930x765)+(1,657x930x765)+(1,657x930x765)		
Heat Exchanger			Cross fin coil			Cross fin coil		
Compressor	Type		Hermetically sealed scroll type			Hermetically sealed scroll type		
	Motor Outputx Number of Units	kW	(6.4x1)+(3.5x1)+(3.5x1)			(3.4x1)+(4.5x1)+(5.6x1)		
	Starting Method		Soft start			Soft start		
Fan	Type		Propeller fan			Propeller fan		
	Motor Output	kW	(0.75x2)+(0.75x2)			(0.55x1)+(0.55x1)+(0.55x1)		
	Airflow Rate	m³/min	257+257			178+178+191		
	Drive		Direct drive			Direct drive		
Connecting Pipes	Liquid Pipe	mm	φ19.1 C1220T (Braze connection)			φ19.1 C1220T (Braze connection)		
	Gas Pipe	mm	φ34.9 C1220T (Braze connection)			φ34.9 C1220T (Braze connection)		
Mass			kg 215+260			kg 175+185+185		
★2 Sound pressure level			dB(A) 63			dB(A) 62		
Safety Devices			High pressure switch, Fan driver overload protector, Over current relay, Inverter overload protector			High pressure switch, Fan driver overload protector, Over current relay, Inverter overload protector		
Capacity Control			% 5-100			% 5-100		
Refrigerant	Refrigerant Name		R410A			R410A		
	Charge	kg	7.4+8.2			5.9+6.7+6.8		
	Control		Electronic expansion valve			Electronic expansion valve		
Refrigerator Oil			Refer to the nameplate of compressor			Refer to the nameplate of compressor		
Standard Accessories			Installation manual, Operation manual, Connection pipes, Clamps			Installation manual, Operation manual, Connection pipes, Clamps		
Drawing No.	Specifications		—			—		
	Sound level		—			—		

Notes:

- ★1. Indoor temp.: 27°CDB, 19°CWB / outdoor temp.: 35°CDB / Equivalent piping length: 7.5 m, level difference: 0 m.
- ★2. Anechoic chamber conversion value, measured at a point 1 m in front of the unit at a height of 1.5 m. During actual operation, these values are normally somewhat higher as a result of ambient conditions.

Conversion formulae
kcal/h=kWx860
Btu/h=kWx3412
clm=m³/minx35.3

Free Combination Specifications

System Capacity			32HP			32HP		
Model Name (Independent Unit)			RXQ12AYM+RXQ20AYM	RXQ12AY14+RXQ20AY14	RXQ12AY1S+RXQ20AY1S	RXQ8AYM+RXQ12AYM+RXQ12AYM	RXQ8AY14+RXQ12AY14+RXQ12AY14	RXQ8AY1S+RXQ12AY1S+RXQ12AY1S
Power Supply			3 phase, 380-415/380 V, 50/60 Hz	3 phase, 380-415 V, 50 Hz	3 phase, 380-415 V, 50 Hz	3 phase, 380-415/380 V, 50/60 Hz	3 phase, 380-415 V, 50 Hz	3 phase, 380-415 V, 50 Hz
★1 Cooling Capacity	kcal/h		77,000			76,900		
	Btu/h		305,000			305,000		
	kW		89.5			89.4		
Casing Color			Ivory white (5Y7.5/1)			Ivory white (5Y7.5/1)		
Dimensions: (HxWxD)			mm (1,657x930x765)+(1,657x1,240x765)			mm (1,657x930x765)+(1,657x930x765)+(1,657x930x765)		
Heat Exchanger			Cross fin coil			Cross fin coil		
Compressor	Type		Hermetically sealed scroll type			Hermetically sealed scroll type		
	Motor Outputx Number of Units	kW	(5.6x1)+(3.8x1)+(6.3x1)			(3.4x1)+(5.6x1)+(5.6x1)		
	Starting Method		Soft start			Soft start		
Fan	Type		Propeller fan			Propeller fan		
	Motor Output	kW	(0.55x1)+(0.75x2)			(0.55x1)+(0.55x1)+(0.55x1)		
	Airflow Rate	m³/min	191+297			178+191+191		
	Drive		Direct drive			Direct drive		
Connecting Pipes	Liquid Pipe	mm	φ19.1 C1220T (Brazing connection)			φ19.1 C1220T (Brazing connection)		
	Gas Pipe	mm	φ34.9 C1220T (Brazing connection)			φ34.9 C1220T (Brazing connection)		
Mass			kg 185+285			kg 175+185+185		
★2 Sound pressure level			dB(A) 66			dB(A) 63		
Safety Devices			High pressure switch, Fan driver overload protector, Over current relay, Inverter overload protector			High pressure switch, Fan driver overload protector, Over current relay, Inverter overload protector		
Capacity Control			% 4-100			% 5-100		
Refrigerant	Refrigerant Name		R410A			R410A		
	Charge	kg	6.8+11.8			5.9+6.8+6.8		
	Control		Electronic expansion valve			Electronic expansion valve		
Refrigerator Oil			Refer to the nameplate of compressor			Refer to the nameplate of compressor		
Standard Accessories			Installation manual, Operation manual, Connection pipes, Clamps			Installation manual, Operation manual, Connection pipes, Clamps		
Drawing No.	Specifications		—			—		
	Sound level		—			—		

System Capacity			34HP			34HP		
Model Name (Independent Unit)			RXQ8AYM+RXQ12AYM+RXQ14AYM	RXQ8AY14+RXQ12AY14+RXQ14AY14	RXQ8AY1S+RXQ12AY1S+RXQ14AY1S	RXQ10AYM+RXQ12AYM+RXQ12AYM	RXQ10AY14+RXQ12AY14+RXQ12AY14	RXQ10AY1S+RXQ12AY1S+RXQ12AY1S
Power Supply			3 phase, 380-415/380 V, 50/60 Hz	3 phase, 380-415 V, 50 Hz	3 phase, 380-415 V, 50 Hz	3 phase, 380-415/380 V, 50/60 Hz	3 phase, 380-415 V, 50 Hz	3 phase, 380-415 V, 50 Hz
★1 Cooling Capacity	kcal/h		82,500			81,700		
	Btu/h		327,000			324,000		
	kW		95.9			95.0		
Casing Color			Ivory white (5Y7.5/1)			Ivory white (5Y7.5/1)		
Dimensions: (HxWxD)			mm (1,657x930x765)+(1,657x930x765)+(1,657x1,240x765)			mm (1,657x930x765)+(1,657x930x765)+(1,657x930x765)		
Heat Exchanger			Cross fin coil			Cross fin coil		
Compressor	Type		Hermetically sealed scroll type			Hermetically sealed scroll type		
	Motor Outputx Number of Units	kW	(3.4x1)+(5.6x1)+(6.4x1)			(4.5x1)+(5.6x1)+(5.6x1)		
	Starting Method		Soft start			Soft start		
Fan	Type		Propeller fan			Propeller fan		
	Motor Output	kW	(0.55x1)+(0.55x1)+(0.75x2)			(0.55x1)+(0.55x1)+(0.55x1)		
	Airflow Rate	m³/min	178+191+257			178+191+191		
	Drive		Direct drive			Direct drive		
Connecting Pipes	Liquid Pipe	mm	φ19.1 C1220T (Brazing connection)			φ19.1 C1220T (Brazing connection)		
	Gas Pipe	mm	φ34.9 C1220T (Brazing connection)			φ34.9 C1220T (Brazing connection)		
Mass			kg 175+185+215			kg 185+185+185		
★2 Sound pressure level			dB(A) 63			dB(A) 63		
Safety Devices			High pressure switch, Fan driver overload protector, Over current relay, Inverter overload protector			High pressure switch, Fan driver overload protector, Over current relay, Inverter overload protector		
Capacity Control			% 4-100			% 4-100		
Refrigerant	Refrigerant Name		R410A			R410A		
	Charge	kg	5.9+6.8+7.4			6.7+6.8+6.8		
	Control		Electronic expansion valve			Electronic expansion valve		
Refrigerator Oil			Refer to the nameplate of compressor			Refer to the nameplate of compressor		
Standard Accessories			Installation manual, Operation manual, Connection pipes, Clamps			Installation manual, Operation manual, Connection pipes, Clamps		
Drawing No.	Specifications		—			—		
	Sound level		—			—		

Notes:

- ★1. Indoor temp.: 27°CDB, 19°CWB / outdoor temp.: 35°CDB / Equivalent piping length: 7.5 m, level difference: 0 m.
- ★2. Anechoic chamber conversion value, measured at a point 1 m in front of the unit at a height of 1.5 m. During actual operation, these values are normally somewhat higher as a result of ambient conditions.

Conversion formulae
kcal/h=kWx860
Btu/h=kWx3412
cfm=m³/minx35.3

System Capacity			36HP			36HP								
Model Name (Independent Unit)			RXQ8AY14+ RXQ14AY14+ RXQ14AY14	RXQ8AY14+ RXQ14AY14+ RXQ14AY14	RXQ8AY14+ RXQ14AY14+ RXQ14AY14	RXQ12AY14+ RXQ12AY14+ RXQ12AY14	RXQ12AY14+ RXQ12AY14+ RXQ12AY14	RXQ12AY14+ RXQ12AY14+ RXQ12AY14						
Power Supply			3 phase, 380-415/380 V, 50/60 Hz			3 phase, 380-415 V, 50 Hz			3 phase, 380-415 V, 50 Hz					
★1 Cooling Capacity			kcal/h			87,700			86,900					
			Btu/h			348,000			345,000					
			kW			102			101					
Casing Color			Ivory white (5Y7.5/1)			Ivory white (5Y7.5/1)								
Dimensions: (HxWxD)			mm			(1,657x930x765)+(1,657x1,240x765)+(1,657x1,240x765)			(1,657x930x765)+(1,657x930x765)+(1,657x930x765)					
Heat Exchanger			Cross fin coil			Cross fin coil								
Compressor			Type			Hermetically sealed scroll type			Hermetically sealed scroll type					
			Motor Outputx Number of Units			kW			(3.4x1)+(6.4x1)+(6.4x1)			(5.6x1)+(5.6x1)+(5.6x1)		
			Starting Method			Soft start			Soft start					
Fan			Type			Propeller fan			Propeller fan					
			Motor Output			kW			(0.55x1)+(0.75x2)+(0.75x2)			(0.55x1)+(0.55x1)+(0.55x1)		
			Airflow Rate			m³/min			178+257+257			191+191+191		
			Drive			Direct drive			Direct drive					
Connecting Pipes			Liquid Pipe			mm			φ19.1 C1220T (Brazeing connection)			φ19.1 C1220T (Brazeing connection)		
			Gas Pipe			mm			φ41.3 C1220T (Brazeing connection)			φ41.3 C1220T (Brazeing connection)		
Mass			kg			175+215+215			185+185+185					
★2 Sound pressure level			dB(A)			64			64					
Safety Devices			High pressure switch, Fan driver overload protector, Over current relay, Inverter overload protector			High pressure switch, Fan driver overload protector, Over current relay, Inverter overload protector								
Capacity Control			%			4-100			4-100					
Refrigerant			Refrigerant Name			R410A			R410A					
			Charge			kg			5.9+7.4+7.4			6.8+6.8+6.8		
			Control			Electronic expansion valve			Electronic expansion valve					
Refrigerator Oil			Refer to the nameplate of compressor			Refer to the nameplate of compressor								
Standard Accessories			Installation manual, Operation manual, Connection pipes, Clamps			Installation manual, Operation manual, Connection pipes, Clamps								
Drawing No.			Specifications			—			—					
			Sound level			—			—					

System Capacity			38HP			38HP								
Model Name (Independent Unit)			RXQ8AY14+ RXQ12AY14+ RXQ18AY14	RXQ8AY14+ RXQ12AY14+ RXQ18AY14	RXQ8AY14+ RXQ12AY14+ RXQ18AY14	RXQ12AY14+ RXQ12AY14+ RXQ14AY14	RXQ12AY14+ RXQ12AY14+ RXQ14AY14	RXQ12AY14+ RXQ12AY14+ RXQ14AY14						
Power Supply			3 phase, 380-415/380 V, 50/60 Hz			3 phase, 380-415 V, 50 Hz			3 phase, 380-415 V, 50 Hz					
★1 Cooling Capacity			kcal/h			91,200			92,000					
			Btu/h			362,000			365,000					
			kW			106			107					
Casing Color			Ivory white (5Y7.5/1)			Ivory white (5Y7.5/1)								
Dimensions: (HxWxD)			mm			(1,657x930x765)+(1,657x930x765)+(1,657x1,240x765)			(1,657x930x765)+(1,657x930x765)+(1,657x1,240x765)					
Heat Exchanger			Cross fin coil			Cross fin coil								
Compressor			Type			Hermetically sealed scroll type			Hermetically sealed scroll type					
			Motor Outputx Number of Units			kW			(3.4x1)+(5.6x1)+(4.0x1)+(4.0x1)			(5.6x1)+(5.6x1)+(6.4x1)		
			Starting Method			Soft start			Soft start					
Fan			Type			Propeller fan			Propeller fan					
			Motor Output			kW			(0.55x1)+(0.55x1)+(0.75x2)			(0.55x1)+(0.55x1)+(0.75x2)		
			Airflow Rate			m³/min			178+191+257			191+191+257		
			Drive			Direct drive			Direct drive					
Connecting Pipes			Liquid Pipe			mm			φ19.1 C1220T (Brazeing connection)			φ19.1 C1220T (Brazeing connection)		
			Gas Pipe			mm			φ41.3 C1220T (Brazeing connection)			φ41.3 C1220T (Brazeing connection)		
Mass			kg			175+185+260			185+185+215					
★2 Sound pressure level			dB(A)			64			64					
Safety Devices			High pressure switch, Fan driver overload protector, Over current relay, Inverter overload protector			High pressure switch, Fan driver overload protector, Over current relay, Inverter overload protector								
Capacity Control			%			4-100			4-100					
Refrigerant			Refrigerant Name			R410A			R410A					
			Charge			kg			5.9+6.8+8.4			6.8+6.8+7.4		
			Control			Electronic expansion valve			Electronic expansion valve					
Refrigerator Oil			Refer to the nameplate of compressor			Refer to the nameplate of compressor								
Standard Accessories			Installation manual, Operation manual, Connection pipes, Clamps			Installation manual, Operation manual, Connection pipes, Clamps								
Drawing No.			Specifications			—			—					
			Sound level			—			—					

Notes:

- ★1. Indoor temp.: 27°CDB, 19°CWB / outdoor temp.: 35°CDB / Equivalent piping length: 7.5 m, level difference: 0 m.
- ★2. Anechoic chamber conversion value, measured at a point 1 m in front of the unit at a height of 1.5 m. During actual operation, these values are normally somewhat higher as a result of ambient conditions.

Conversion formulae
kcal/h=kWx860
Btu/h=kWx3412
cfm=m³/minx35.3

Free Combination Specifications

System Capacity			40HP			40HP		
Model Name (Independent Unit)			RXQ12AYM+ RXQ12AYM+ RXQ16AYM	RXQ12AY14+ RXQ12AY14+ RXQ16AY14	RXQ12AY1S+ RXQ12AY1S+ RXQ16AY1S	RXQ12AYM+ RXQ14AYM+ RXQ14AYM	RXQ12AY14+ RXQ14AY14+ RXQ14AY14	RXQ12AY1S+ RXQ14AY1S+ RXQ14AY1S
Power Supply			3 phase, 380-415/380 V, 50/60 Hz	3 phase, 380-415 V, 50 Hz	3 phase, 380-415 V, 50 Hz	3 phase, 380-415/380 V, 50/60 Hz	3 phase, 380-415 V, 50 Hz	3 phase, 380-415 V, 50 Hz
★1 Cooling Capacity	kcal/h		96,300			98,000		
	Btu/h		382,000			389,000		
	kW		112			114		
Casing Color			Ivory white (5Y7.5/1)			Ivory white (5Y7.5/1)		
Dimensions: (HxWxD)			mm (1,657x930x765)+(1,657x930x765)+(1,657x1,240x765)			mm (1,657x930x765)+(1,657x1,240x765)+(1,657x1,240x765)		
Heat Exchanger			Cross fin coil			Cross fin coil		
Compressor	Type		Hermetically sealed scroll type			Hermetically sealed scroll type		
	Motor Outputx Number of Units	kW	(5.6x1)+(5.6x1)+(3.5x1)+(3.5x1)			(5.6x1)+(6.4x1)+(6.4x1)		
	Starting Method		Soft start			Soft start		
Fan	Type		Propeller fan			Propeller fan		
	Motor Output	kW	(0.55x1)+(0.55x1)+(0.75x2)			(0.55x1)+(0.75x2)+(0.75x2)		
	Airflow Rate	m³/min	191+191+257			191+257+257		
	Drive		Direct drive			Direct drive		
Connecting Pipes	Liquid Pipe	mm	φ19.1 C1220T (Brazing connection)			φ19.1 C1220T (Brazing connection)		
	Gas Pipe	mm	φ41.3 C1220T (Brazing connection)			φ41.3 C1220T (Brazing connection)		
Mass			kg 185+185+260			kg 185+215+215		
★2 Sound pressure level			dB(A) 64			dB(A) 64		
Safety Devices			High pressure switch, Fan driver overload protector, Over current relay, Inverter overload protector			High pressure switch, Fan driver overload protector, Over current relay, Inverter overload protector		
Capacity Control			% 4-100			% 4-100		
Refrigerant	Refrigerant Name		R410A			R410A		
	Charge	kg	6.8+6.8+8.2			6.8+7.4+7.4		
	Control		Electronic expansion valve			Electronic expansion valve		
Refrigerator Oil			Refer to the nameplate of compressor			Refer to the nameplate of compressor		
Standard Accessories			Installation manual, Operation manual, Connection pipes, Clamps			Installation manual, Operation manual, Connection pipes, Clamps		
Drawing No.	Specifications		—			—		
	Sound level		—			—		

System Capacity			42HP			42HP		
Model Name (Independent Unit)			RXQ12AYM+ RXQ14AYM+ RXQ16AYM	RXQ12AY14+ RXQ14AY14+ RXQ16AY14	RXQ12AY1S+ RXQ14AY1S+ RXQ16AY1S	RXQ14AYM+ RXQ14AYM+ RXQ14AYM	RXQ14AY14+ RXQ14AY14+ RXQ14AY14	RXQ14AY1S+ RXQ14AY1S+ RXQ14AY1S
Power Supply			3 phase, 380-415/380 V, 50/60 Hz	3 phase, 380-415 V, 50 Hz	3 phase, 380-415 V, 50 Hz	3 phase, 380-415/380 V, 50/60 Hz	3 phase, 380-415 V, 50 Hz	3 phase, 380-415 V, 50 Hz
★1 Cooling Capacity	kcal/h		102,300			103,200		
	Btu/h		406,000			409,000		
	kW		119			120		
Casing Color			Ivory white (5Y7.5/1)			Ivory white (5Y7.5/1)		
Dimensions: (HxWxD)			mm (1,657x930x765)+(1,657x1,240x765)+(1,657x1,240x765)			mm (1,657x1,240x765)+(1,657x1,240x765)+(1,657x1,240x765)		
Heat Exchanger			Cross fin coil			Cross fin coil		
Compressor	Type		Hermetically sealed scroll type			Hermetically sealed scroll type		
	Motor Outputx Number of Units	kW	(5.6x1)+(6.4x1)+(3.5x1)+(3.5x1)			(6.4x1)+(6.4x1)+(6.4x1)		
	Starting Method		Soft start			Soft start		
Fan	Type		Propeller fan			Propeller fan		
	Motor Output	kW	(0.55x1)+(0.75x2)+(0.75x2)			(0.75x2)+(0.75x2)+(0.75x2)		
	Airflow Rate	m³/min	191+257+257			257+257+257		
	Drive		Direct drive			Direct drive		
Connecting Pipes	Liquid Pipe	mm	φ19.1 C1220T (Brazing connection)			φ19.1 C1220T (Brazing connection)		
	Gas Pipe	mm	φ41.3 C1220T (Brazing connection)			φ41.3 C1220T (Brazing connection)		
Mass			kg 185+215+260			kg 215+215+215		
★2 Sound pressure level			dB(A) 64			dB(A) 65		
Safety Devices			High pressure switch, Fan driver overload protector, Over current relay, Inverter overload protector			High pressure switch, Fan driver overload protector, Over current relay, Inverter overload protector		
Capacity Control			% 3-100			% 4-100		
Refrigerant	Refrigerant Name		R410A			R410A		
	Charge	kg	6.8+7.4+8.2			7.4+7.4+7.4		
	Control		Electronic expansion valve			Electronic expansion valve		
Refrigerator Oil			Refer to the nameplate of compressor			Refer to the nameplate of compressor		
Standard Accessories			Installation manual, Operation manual, Connection pipes, Clamps			Installation manual, Operation manual, Connection pipes, Clamps		
Drawing No.	Specifications		—			—		
	Sound level		—			—		

Notes:

- ★1. Indoor temp.: 27°CDB, 19°CWB / outdoor temp.: 35°CDB / Equivalent piping length: 7.5 m, level difference: 0 m.
- ★2. Anechoic chamber conversion value, measured at a point 1 m in front of the unit at a height of 1.5 m.
During actual operation, these values are normally somewhat higher as a result of ambient conditions.

Conversion formulae
kcal/h=kWx860
Btu/h=kWx3412
cfm=m³/minx35.3

System Capacity			44HP			44HP								
Model Name (Independent Unit)			RXQ12AYM+ RXQ16AYM+ RXQ16AYM	RXQ12AY14+ RXQ16AY14+ RXQ16AY14	RXQ12AY1S+ RXQ16AY1S+ RXQ16AY1S	RXQ14AYM+ RXQ14AYM+ RXQ16AYM	RXQ14AY14+ RXQ14AY14+ RXQ16AY14	RXQ14AY1S+ RXQ14AY1S+ RXQ16AY1S						
Power Supply			3 phase, 380-415/380 V, 50/60 Hz			3 phase, 380-415 V, 50 Hz			3 phase, 380-415 V, 50 Hz					
★1 Cooling Capacity			kcal/h			106,600			107,500					
			Btu/h			423,000			427,000					
			kW			124			125					
Casing Color			Ivory white (5Y7.5/1)			Ivory white (5Y7.5/1)								
Dimensions: (HxWxD)			mm			(1,657x930x765)+(1,657x1,240x765)+(1,657x1,240x765)			(1,657x1,240x765)+(1,657x1,240x765)+(1,657x1,240x765)					
Heat Exchanger			Cross fin coil			Cross fin coil								
Compressor			Type			Hermetically sealed scroll type			Hermetically sealed scroll type					
			Motor Outputx Number of Units			kW			(5.6x1)+(3.5x1)+(3.5x1)+(3.5x1)+(3.5x1)			(6.4x1)+(6.4x1)+(3.5x1)+(3.5x1)		
			Starting Method			Soft start			Soft start					
Fan			Type			Propeller fan			Propeller fan					
			Motor Output			kW			(0.55x2)+(0.75x2)+(0.75x2)			(0.75x2)+(0.75x2)+(0.75x2)		
			Airflow Rate			m³/min			191+257+257			257+257+257		
			Drive			Direct drive			Direct drive					
Connecting Pipes			Liquid Pipe			mm			φ19.1 C1220T (Brazeing connection)			φ19.1 C1220T (Brazeing connection)		
			Gas Pipe			mm			φ41.3 C1220T (Brazeing connection)			φ41.3 C1220T (Brazeing connection)		
Mass			kg			185+260+260			215+215+260					
★2 Sound pressure level			dB(A)			64			65					
Safety Devices			High pressure switch, Fan driver overload protector, Over current relay, Inverter overload protector			High pressure switch, Fan driver overload protector, Over current relay, Inverter overload protector								
Capacity Control			%			3-100			3-100					
Refrigerant			Refrigerant Name			R410A			R410A					
			Charge			kg			6.8+8.2+8.2			7.4+7.4+8.2		
			Control			Electronic expansion valve			Electronic expansion valve					
Refrigerator Oil			Refer to the nameplate of compressor			Refer to the nameplate of compressor								
Standard Accessories			Installation manual, Operation manual, Connection pipes, Clamps			Installation manual, Operation manual, Connection pipes, Clamps								
Drawing No.			Specifications			—			—					
			Sound level			—			—					

System Capacity			46HP			46HP								
Model Name (Independent Unit)			RXQ12AYM+ RXQ16AYM+ RXQ18AYM	RXQ12AY14+ RXQ16AY14+ RXQ18AY14	RXQ12AY1S+ RXQ16AY1S+ RXQ18AY1S	RXQ14AYM+ RXQ16AYM+ RXQ16AYM	RXQ14AY14+ RXQ16AY14+ RXQ16AY14	RXQ14AY1S+ RXQ16AY1S+ RXQ16AY1S						
Power Supply			3 phase, 380-415/380 V, 50/60 Hz			3 phase, 380-415 V, 50 Hz			3 phase, 380-415 V, 50 Hz					
★1 Cooling Capacity			kcal/h			110,900			111,800					
			Btu/h			440,000			444,000					
			kW			129			130					
Casing Color			Ivory white (5Y7.5/1)			Ivory white (5Y7.5/1)								
Dimensions: (HxWxD)			mm			(1,657x930x765)+(1,657x1,240x765)+(1,657x1,240x765)			(1,657x1,240x765)+(1,657x1,240x765)+(1,657x1,240x765)					
Heat Exchanger			Cross fin coil			Cross fin coil								
Compressor			Type			Hermetically sealed scroll type			Hermetically sealed scroll type					
			Motor Outputx Number of Units			kW			(5.6x1)+(3.5x1)+(3.5x1)+(4.0x1)+(4.0x1)			(6.4x1)+(3.5x1)+(3.5x1)+(3.5x1)+(3.5x1)		
			Starting Method			Soft start			Soft start					
Fan			Type			Propeller fan			Propeller fan					
			Motor Output			kW			(0.55x1)+(0.75x2)+(0.75x2)			(0.75x2)+(0.75x2)+(0.75x2)		
			Airflow Rate			m³/min			191+257+257			257+257+257		
			Drive			Direct drive			Direct drive					
Connecting Pipes			Liquid Pipe			mm			φ19.1 C1220T (Brazeing connection)			φ19.1 C1220T (Brazeing connection)		
			Gas Pipe			mm			φ41.3 C1220T (Brazeing connection)			φ41.3 C1220T (Brazeing connection)		
Mass			kg			185+260+260			215+260+260					
★2 Sound pressure level			dB(A)			65			65					
Safety Devices			High pressure switch, Fan driver overload protector, Over current relay, Inverter overload protector			High pressure switch, Fan driver overload protector, Over current relay, Inverter overload protector								
Capacity Control			%			3-100			3-100					
Refrigerant			Refrigerant Name			R410A			R410A					
			Charge			kg			6.8+8.2+8.4			7.4+8.2+8.2		
			Control			Electronic expansion valve			Electronic expansion valve					
Refrigerator Oil			Refer to the nameplate of compressor			Refer to the nameplate of compressor								
Standard Accessories			Installation manual, Operation manual, Connection pipes, Clamps			Installation manual, Operation manual, Connection pipes, Clamps								
Drawing No.			Specifications			—			—					
			Sound level			—			—					

Notes:

- ★1. Indoor temp.: 27°CDB, 19°CWB / outdoor temp.: 35°CDB / Equivalent piping length: 7.5 m, level difference: 0 m.
★2. Anechoic chamber conversion value, measured at a point 1 m in front of the unit at a height of 1.5 m.
During actual operation, these values are normally somewhat higher as a result of ambient conditions.

Conversion formulae
kcal/h=kWx860
Btu/h=kWx3412
clm=m³/minx35.3

Free Combination Specifications

System Capacity			48HP			48HP					
Model Name (Independent Unit)			RXQ12AYM+ RXQ18AYM+ RXQ18AYM	RXQ12AY14+ RXQ18AY14+ RXQ18AY14	RXQ12AY1S+ RXQ18AY1S+ RXQ18AY1S	RXQ16AYM+ RXQ16AYM+ RXQ16AYM	RXQ16AY14+ RXQ16AY14+ RXQ16AY14	RXQ16AY1S+ RXQ16AY1S+ RXQ16AY1S			
Power Supply			3 phase, 380-415/380 V, 50/60 Hz			3 phase, 380-415 V, 50 Hz			3 phase, 380-415 V, 50 Hz		
★1 Cooling Capacity	kcal/h		115,200			116,100					
	Btu/h		457,000			461,000					
	kW		134			135					
Casing Color			Ivory white (5Y7.5/1)			Ivory white (5Y7.5/1)					
Dimensions: (HxWxD)			mm (1,657x930x765)+(1,657x1,240x765)+(1,657x1,240x765)			mm (1,657x1,240x765)+(1,657x1,240x765)+(1,657x1,240x765)					
Heat Exchanger			Cross fin coil			Cross fin coil					
Compressor	Type		Hermetically sealed scroll type			Hermetically sealed scroll type					
	Motor Output	Number of Units	kW (5.6x1)+(4.0x1)+(4.0x1)+(4.0x1)+(4.0x1)			kW (3.5x1)+(3.5x1)+(3.5x1)+(3.5x1)+(3.5x1)+(3.5x1)					
	Starting Method		Soft start			Soft start					
Fan	Type		Propeller fan			Propeller fan					
	Motor Output	kW	(0.55x1)+(0.75x2)+(0.75x2)			(0.75x2)+(0.75x2)+(0.75x2)					
	Airflow Rate	m ³ /min	191+257+257			257+257+257					
	Drive		Direct drive			Direct drive					
Connecting Pipes	Liquid Pipe	mm	φ19.1 C1220T (Brazing connection)			φ19.1 C1220T (Brazing connection)					
	Gas Pipe	mm	φ41.3 C1220T (Brazing connection)			φ41.3 C1220T (Brazing connection)					
Mass			kg 185+260+260			kg 260+260+260					
★2 Sound pressure level			dB(A) 65			dB(A) 65					
Safety Devices			High pressure switch, Fan driver overload protector, Over current relay, Inverter overload protector			High pressure switch, Fan driver overload protector, Over current relay, Inverter overload protector					
Capacity Control			% 3-100			% 3-100					
Refrigerant	Refrigerant Name		R410A			R410A					
	Charge	kg	6.8+8.4+8.4			8.2+8.2+8.2					
	Control		Electronic expansion valve			Electronic expansion valve					
Refrigerator Oil			Refer to the nameplate of compressor			Refer to the nameplate of compressor					
Standard Accessories			Installation manual, Operation manual, Connection pipes, Clamps			Installation manual, Operation manual, Connection pipes, Clamps					
Drawing No.	Specifications		—			—					
	Sound level		—			—					

System Capacity			50HP			50HP					
Model Name (Independent Unit)			RXQ12AYM+ RXQ18AYM+ RXQ20AYM	RXQ12AY14+ RXQ18AY14+ RXQ20AY14	RXQ12AY1S+ RXQ18AY1S+ RXQ20AY1S	RXQ16AYM+ RXQ16AYM+ RXQ18AYM	RXQ16AY14+ RXQ16AY14+ RXQ18AY14	RXQ16AY1S+ RXQ16AY1S+ RXQ18AY1S			
Power Supply			3 phase, 380-415/380 V, 50/60 Hz			3 phase, 380-415 V, 50 Hz			3 phase, 380-415 V, 50 Hz		
★1 Cooling Capacity	kcal/h		120,400			120,400					
	Btu/h		478,000			478,000					
	kW		140			140					
Casing Color			Ivory white (5Y7.5/1)			Ivory white (5Y7.5/1)					
Dimensions: (HxWxD)			mm (1,657x930x765)+(1,657x1,240x765)+(1,657x1,240x765)			mm (1,657x1,240x765)+(1,657x1,240x765)+(1,657x1,240x765)					
Heat Exchanger			Cross fin coil			Cross fin coil					
Compressor	Type		Hermetically sealed scroll type			Hermetically sealed scroll type					
	Motor Output	Number of Units	kW (5.6x1)+(4.0x1)+(4.0x1)+(3.8x1)+(6.3x1)			kW (3.5x1)+(3.5x1)+(3.5x1)+(3.5x1)+(4.0x1)+(4.0x1)					
	Starting Method		Soft start			Soft start					
Fan	Type		Propeller fan			Propeller fan					
	Motor Output	kW	(0.55x1)+(0.75x2)+(0.75x2)			(0.75x2)+(0.75x2)+(0.75x2)					
	Airflow Rate	m ³ /min	191+257+297			257+257+257					
	Drive		Direct drive			Direct drive					
Connecting Pipes	Liquid Pipe	mm	φ19.1 C1220T (Brazing connection)			φ19.1 C1220T (Brazing connection)					
	Gas Pipe	mm	φ41.3 C1220T (Brazing connection)			φ41.3 C1220T (Brazing connection)					
Mass			kg 185+260+285			kg 260+260+260					
★2 Sound pressure level			dB(A) 67			dB(A) 65					
Safety Devices			High pressure switch, Fan driver overload protector, Over current relay, Inverter overload protector			High pressure switch, Fan driver overload protector, Over current relay, Inverter overload protector					
Capacity Control			% 3-100			% 3-100					
Refrigerant	Refrigerant Name		R410A			R410A					
	Charge	kg	6.8+8.4+11.8			8.2+8.2+8.4					
	Control		Electronic expansion valve			Electronic expansion valve					
Refrigerator Oil			Refer to the nameplate of compressor			Refer to the nameplate of compressor					
Standard Accessories			Installation manual, Operation manual, Connection pipes, Clamps			Installation manual, Operation manual, Connection pipes, Clamps					
Drawing No.	Specifications		—			—					
	Sound level		—			—					

Notes:

- ★1. Indoor temp.: 27°CDB, 19°CWB / outdoor temp.: 35°CDB / Equivalent piping length: 7.5 m, level difference: 0 m.
- ★2. Anechoic chamber conversion value, measured at a point 1 m in front of the unit at a height of 1.5 m. During actual operation, these values are normally somewhat higher as a result of ambient conditions.

Conversion formulae
kcal/h=kWx860
Btu/h=kWx3412
cfm=m ³ /minx35.3

**Warning**

- Ask a qualified installer or contractor to install this product. Do not try to install the product yourself. Improper installation can result in water or refrigerant leakage, electrical shock, fire or explosion.
- Use only those parts and accessories supplied or specified by Daikin. Ask a qualified installer or contractor to install those parts and accessories. Use of unauthorised parts and accessories or improper installation of parts and accessories can result in water or refrigerant leakage, electrical shock, fire or explosion.
- Read the user's manual carefully before using this product. The user's manual provides important safety instructions and warnings. Be sure to follow these instructions and warnings.

If you have any enquiries, please contact your local importer, distributor and/or retailer.

Cautions on product corrosion

1. Air conditioners should not be installed in areas where corrosive gases, such as acid gas or alkaline gas, are produced.
2. If the outdoor unit is to be installed close to the sea shore, direct exposure to the sea breeze should be avoided. If you need to install the outdoor unit close to the sea shore, contact your local distributor.

SIAM DAIKIN SALES CO.,LTD.

22 Soi Onnuch 55/1
Pravet Subdistrict, Pravet District,
Bangkok 10250

Tel. 0-2838-3200
Fax. 0-2721-7607



VRV is a trademark of Daikin Industries, Ltd.

VRV Air Conditioning System is the world's first individual air conditioning system with variable refrigerant flow control and was commercialised by Daikin in 1982.

VRV is the trademark of Daikin Industries, Ltd., which is derived from the technology we call "variable refrigerant volume."

Specifications, designs and other content appearing in this brochure are current as of December 2017 but subject to change without notice.

©All rights reserved
SS